



ASSEMBLY INSTRUCTIONS

ITEM#: A102015331/A102015331B1/A102015331B2

SKU#: 810670189/810670187/810670188

BANCROFT 10X12FT HARD TOP METAL GAZEBO

Need help? We are here for you! 1(866)578-6569 24/7 • Toll Free

GENERAL BEST PRACTICES FOR ASSEMBLY:

- Please read and understand this entire manual before attempting to assemble or install the product.
 - Before beginning assembly of product, make sure all parts are present. Compare parts with package contents list and hardware contents list. If any part is missing or damaged, do not attempt to assemble the product.
 - The assembled gazebo should be located at least 6 feet from any obstruction such as fence, garage, house, overhanging branches, laundry lines or electrical wires.
 - Some parts may contain sharp edges. Wear protective gloves if necessary, during assembly.
 - This unit is heavy. For safety, do not assemble this item alone. Four people are recommended for safe assembly.
 - Check all nuts and bolts periodically for tightness and, when required, tighten them again.
 - Pay attention to the parts orientation
-
-

WARNINGS:

- Install the gazebo on level ground. Stakes are provided to secure the gazebo to the ground.
 - Do not assemble the gazebo on sandy, muddy or loose soil, as stakes do not have enough anchorage in these types of soil.
 - If you wish to secure the gazebo to a wood deck or concrete surface, use anchors suited to these surfaces.
 - Snow must be cleared off regularly during snowy days. Remove the snow at the roof top when it is thicker than 2 inches. In order to avoid damage, use a plastic snow rake to remove excessive snow and ice buildup from roof and keep away from falling debris.
 - Any assembly or maintenance of the product must be carried out by adults only.
 - Please check your state and local regulations prior to purchasing. Some jurisdictions may require permits for installation and use. Some special procedures may be valid in your area.
 - If any scratch paint, please touch up to prevent rusting
 - For outdoor use only.
-
-

WARRANTY:

WHAT IS COVERED?

The limited warranty is extended to the original purchaser and applies to material and manufacturer's defect provided the item is maintained with care and used only for personal, residential purposes.

For further assistance, please email Biglots@sunjoygroup.com

Warranty: 1 Year







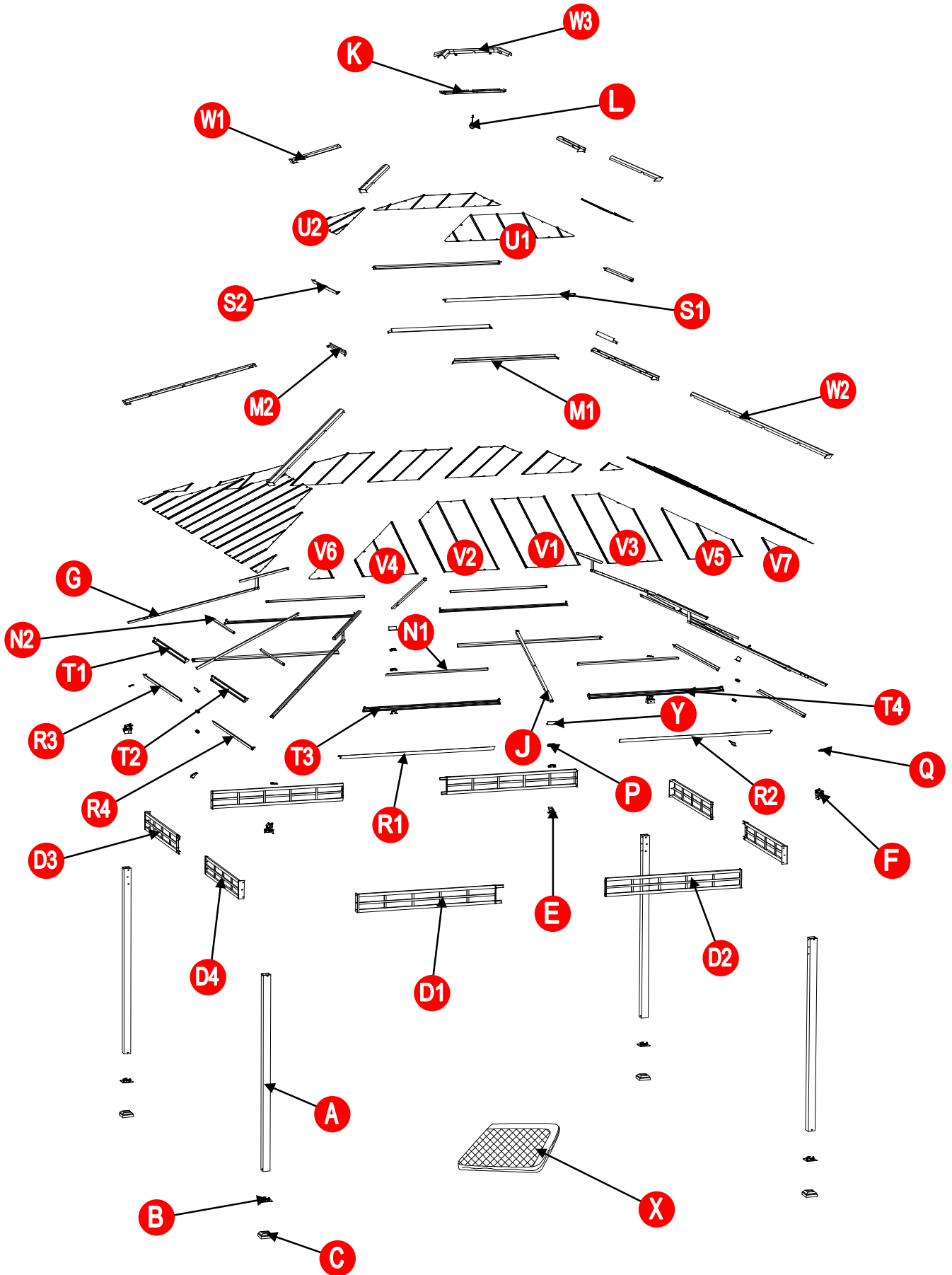



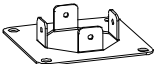
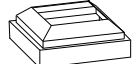

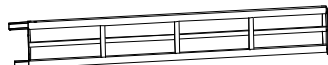
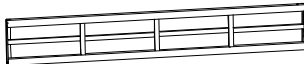
MAINTENANCE:











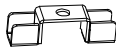
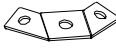

- Steel components for this gazebo are treated with rust inhibiting paint that protects it from rusting. However, due to the nature of steel, surface oxidation (rusting) will occur if these protective coatings are scratched. This is not a defect and thus not covered by the warranty.
 - To minimize this condition, it is recommended to use care when assembling and handling the product to prevent scratching the paint. Should any scratching or damage occur, it is recommended to cover the scratch immediately with rust inhibiting paint (not included).
 - Surface rust can also be easily removed with a very light application of regular cooking oil or WD-40. If surface oxidation (rusting) occurs and if no measure is taken to prevent this, the oxidation may start dripping onto deck or patio and caused damaging stains, which may be difficult to remove. This can be prevented if the above-mentioned measures are taken to keep the product from oxidizing.
 - Do not use bleach, acid, or other abrasive cleaners on the roof or frame parts.
 - Keep instruction manual for future reference.
 - Keep the original packaging to store the gazebo.
 - Periodically check and ensure that all bolts are well-tighten during use
-
-







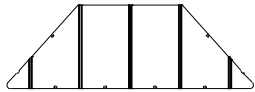
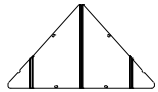

EXPLODED DRAWING

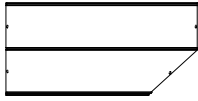
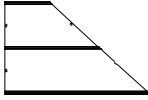
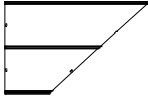





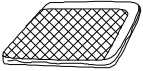

PARTS LIST

Label	Part Number	Description	Qty	Part Image
A	P00020087901	Post	4	
B	P00010056401	Post Base	4	
C	P00610030101	Base Cover	4	
D1	P00040168401	Left Cross Beam (Long Side)	2	
D2	P00040168501	Right Cross Beam (Long Side)	2	
D3	P00040167601	Left Cross Beam (Short Side)	2	
D4	P00040167701	Right Cross Beam (Short Side)	2	
E	P00050222201	Middle Beam Connector	4	
F	P00050214001	Rafter Connector	4	
G	P00060295401	Rafter	4	
J	P00060295501	Middle Beam	4	
K	P00050222101	Small Connector	1	
L	P00580015401	Hook	1	
M1	P00060296001	Big Roof Up Long Panel Flashing	2	
M2	P00060296101	Big Roof Up Short Panel Flashing	2	
N1	P00060296201	Big Roof Long Small Beam	4	
N2	P00060296301	Big Roof Short Small Beam	4	

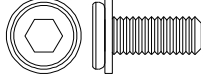
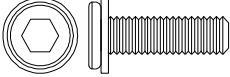
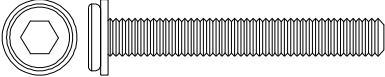
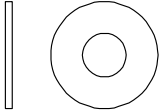
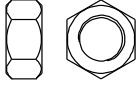
P	P00050214101	Beam Connector 1	8	
Q	P00050214201	Beam Connector 2	4	
R1	P00060295601	Big Roof Long Panel Flashing 1	2	
R2	P00060295701	Big Roof Long Panel Flashing 2	2	
R3	P00060295801	Big Roof Short Panel Flashing 1	2	
R4	P00060295901	Big Roof Short Panel Flashing 2	2	
S1	P00060296401	Small Roof Low Long Panel Flashing	2	
S2	P00060296501	Small Roof Low Short Panel Flashing	2	
T1	P00570041601	Left Short Mosquito Netting Rod	2	
T2	P00570041701	Right Short Mosquito Netting Rod	2	
T3	P00570041801	Left Long Mosquito Netting Rod	2	
T4	P00570041901	Right Long Mosquito Netting Rod	2	
U1	P00070142301	Small Roof Long Side Roof Panel	2	
U2	P00070142401	Small Roof Short Side Roof Panel	2	
V1	P00070142501	Big Roof Middle Roof Panel	2	

V2	P00070142601	Big Roof Left Roof Panel	4	
V3	P00070142701	Big Roof Right Roof Panel	4	
V4	P00070142801	Big Roof Left Middle Roof Panel	4	
V5	P00070142901	Big Roof Right Middle Roof Panel	4	
V6	P00070143001	Big Roof Left Small Roof Panel	4	
V7	P00070143101	Big Roof Right Small Roof Panel	4	
W1	P00080051601	Small Roof Rafter Cap	4	
W2	P00080050301	Big Roof Rafter Cap	4	
W3	P00090022001	Top Cover	1	
X	P00120031001	Mosquito Netting	1	
Y	P00560056601	Middle Beam Decoration	4	

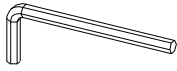
HARDWARE LIST

Label	Part Number	Description	Qty	Add	Part Image
H1	H100010090	Bolt M6*15	228	12	
H2	H100010050	Bolt M6*20	10	1	
H3	H100010101	Bolt M6*45	12	1	
H4	H050030001	Flat washer M6	8	1	
H5	H040010004	Nut M6	8	1	
HH1	H050050018	M6 Rubber Washer	12	1	
HH2	H990010031	Plastic Buckle	12	1	
HR	H990050001	Ring	52	3	
HS	H070010003	Stake $\Phi 8*180$	8	0	
HW1	H090030002	Allen Wrench M6	2	0	
HW2	H090010017	Wrench M6	1	0	

HELPFUL HINTS

- Tools needed and not included:
- How many people needed for the installation work
- Estimate assemble time: 150-180 minutes

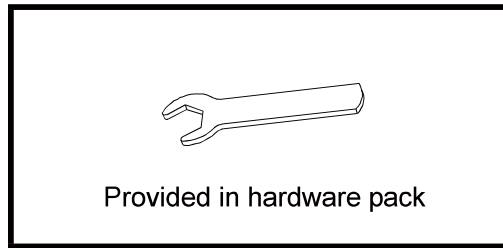
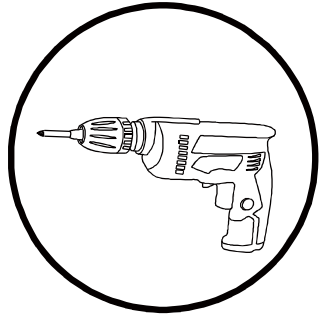
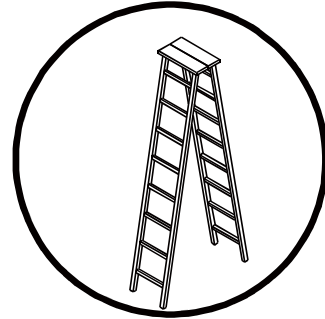
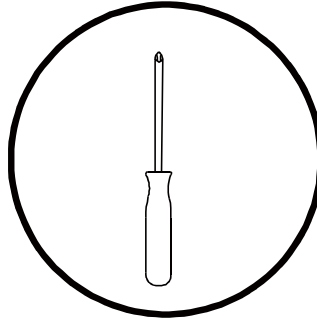
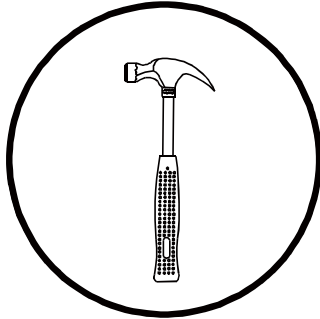

How many people needed for the installation

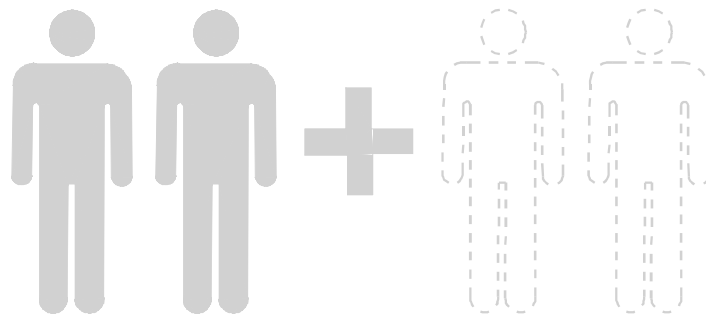

STEP 1

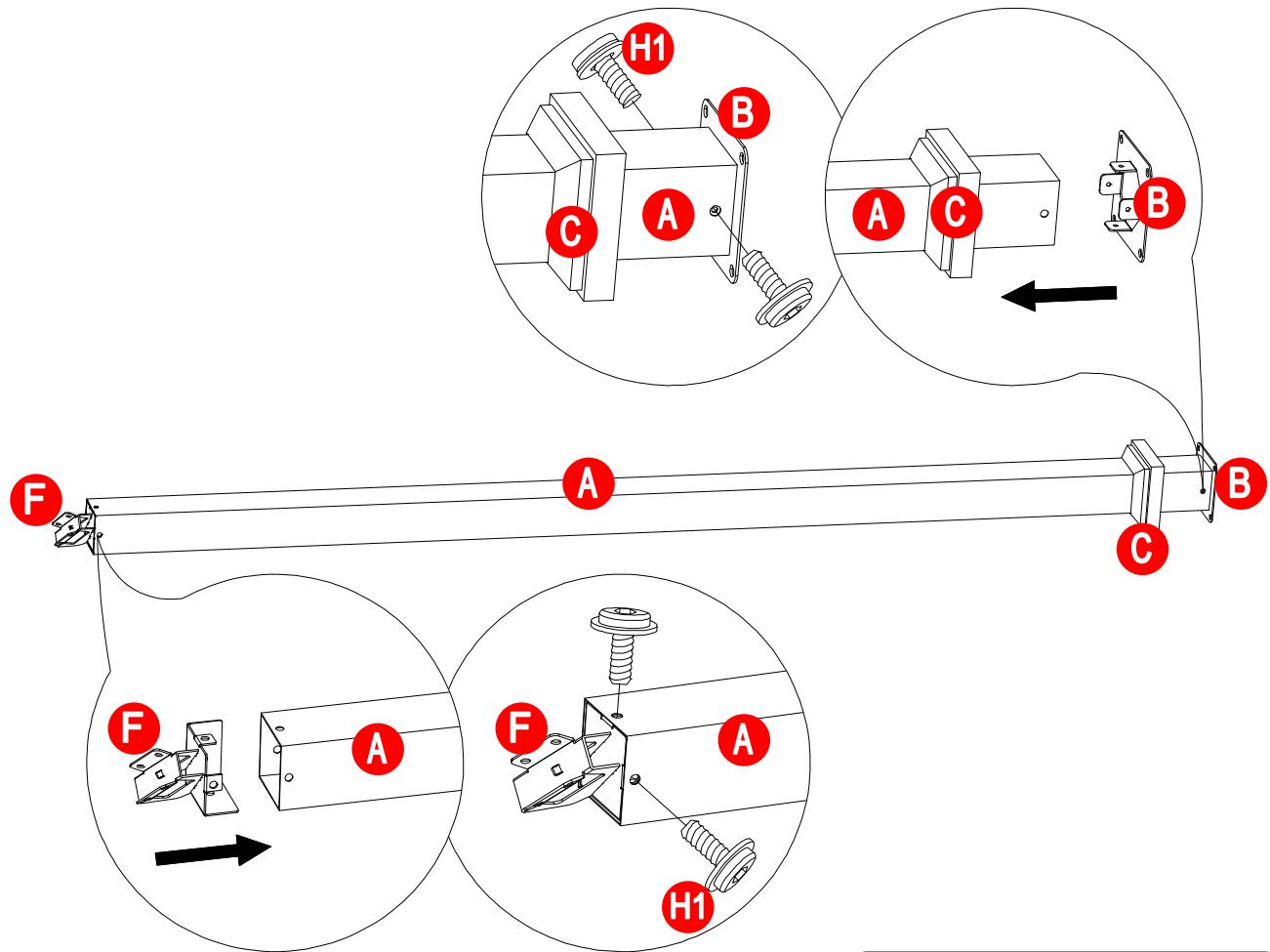
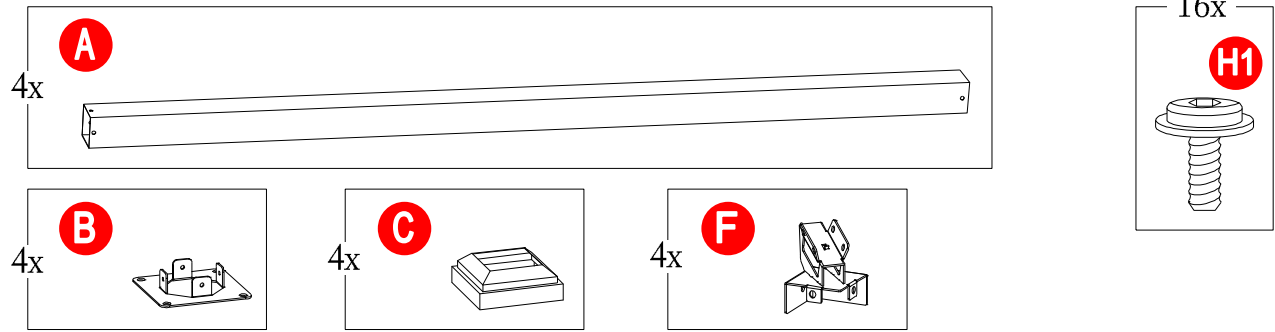

Insert Base Cover(C) onto the post(A), assemble the post base(B) and Rafter Connector(F) on the post(A) with bolts(H1), tighten by Allen wrench (HW1).

Assembled View:



STEP 2

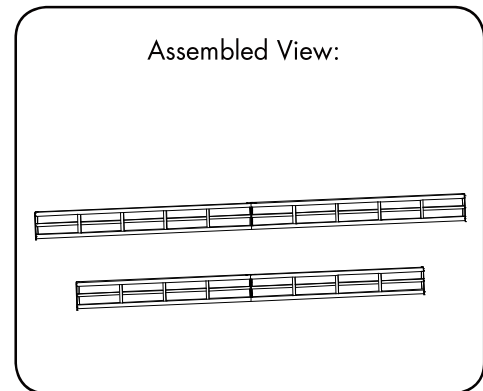
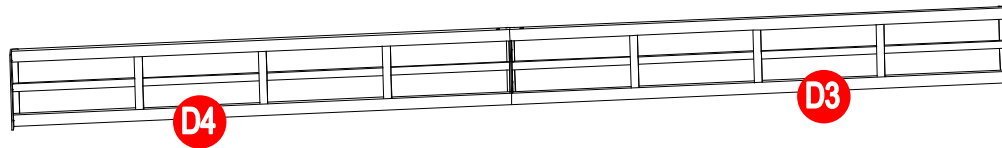
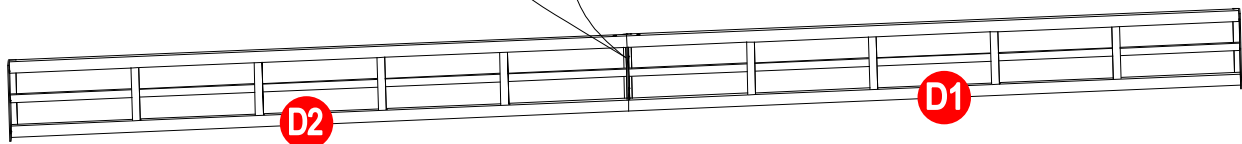
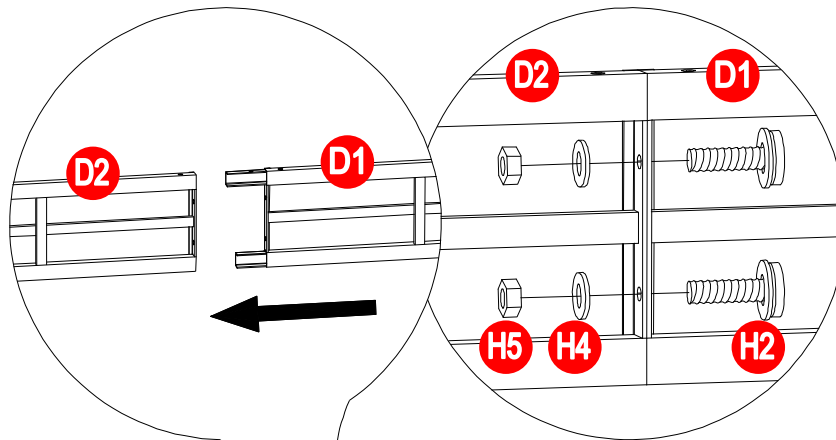
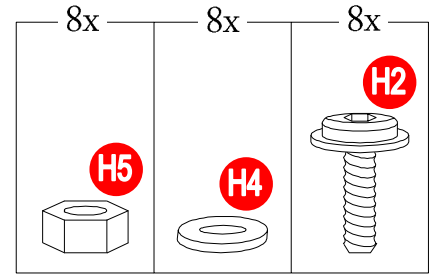
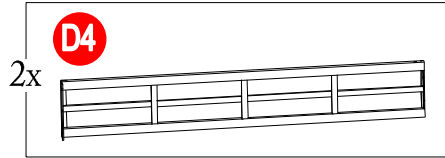
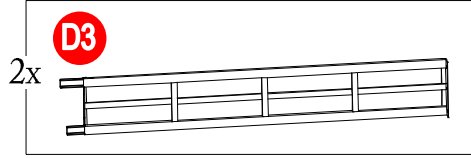
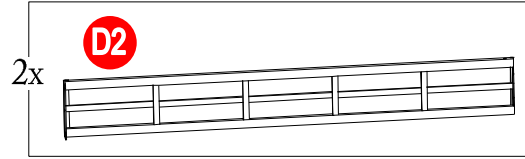
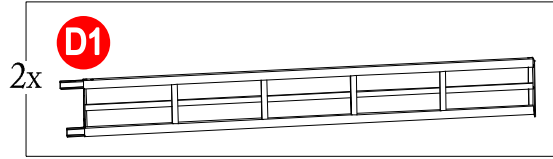

Connecting Left Cross Beam (Long Side)(D1) and Right Cross Beam (Long Side)(D2) with bolt(H2), flat washer(H4) and nut(H5), Connecting Left Cross Beam (Short Side)(D3) and Right Cross Beam (Short Side)(D4) with bolt(H2), flat washer(H4) and nut(H5), tighten by wrench (HW1).

STEP 3

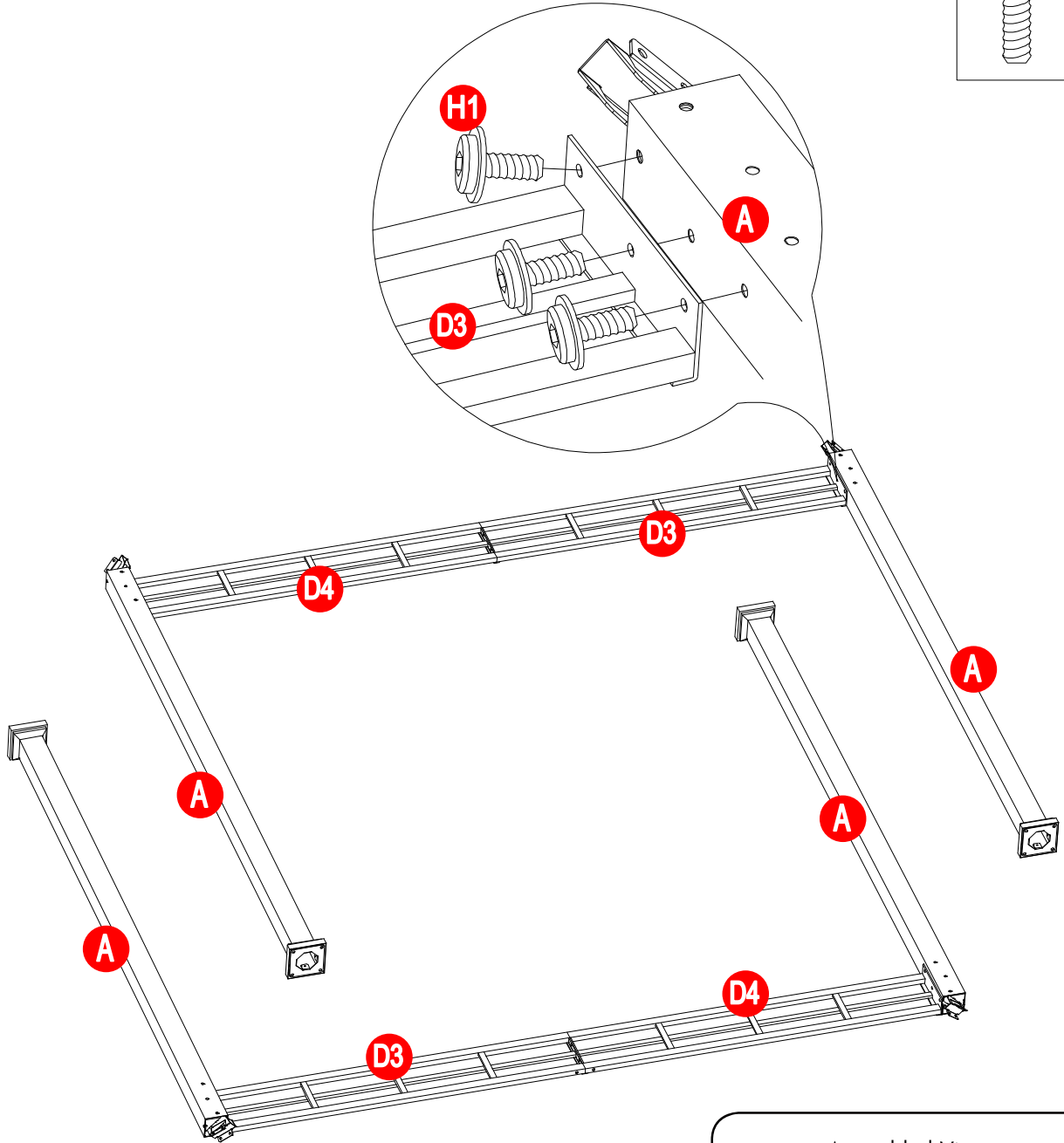
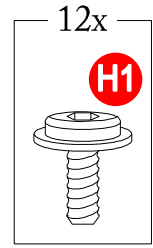

Assemble the Left Cross Beam (Short Side)(D3) and Right Cross Beam (Short Side)(D4) to post(A) with bolts(H1), tighten by wrench (HW1).

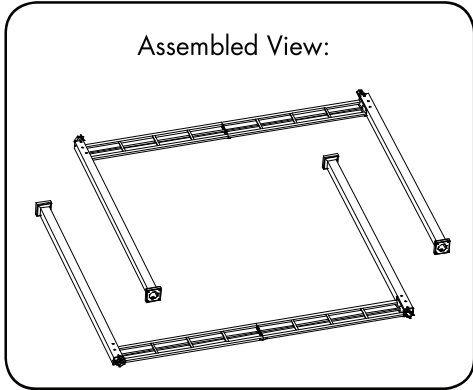

STEP 4

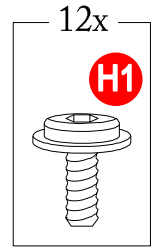
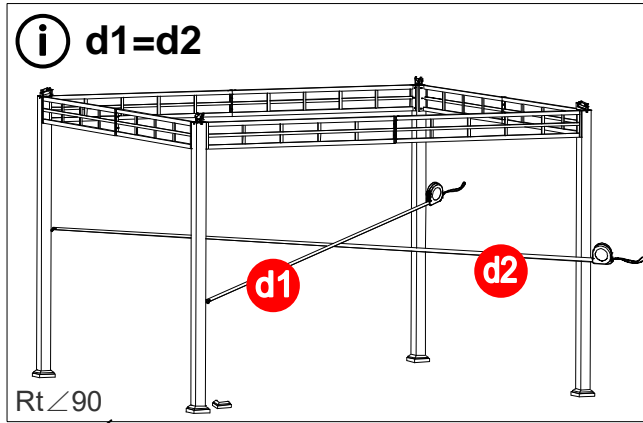

Assembly Tip on Step 4:

Please measure to make sure the length of d1 is equal to d2 before moving to next step to ensure a square frame and best results. Keep the beam at right angles to the post, the post at right angles to the ground, and keep the beam horizontal.

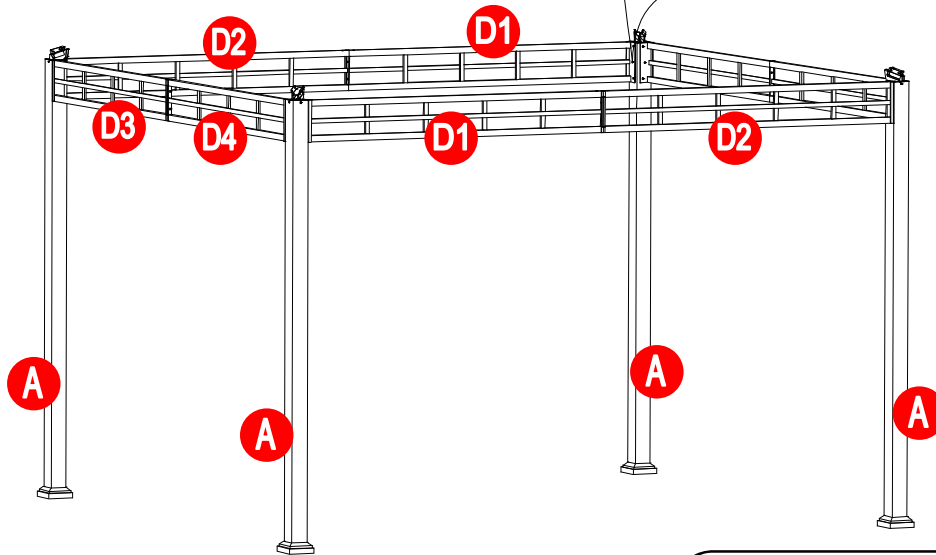
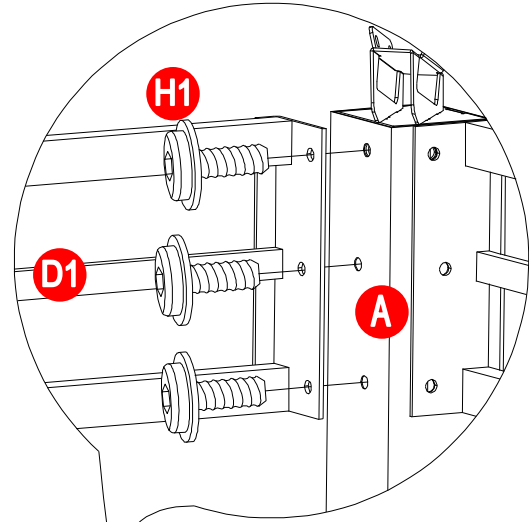

Assembled View:

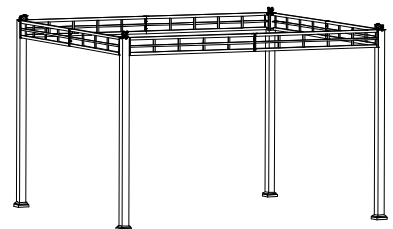

Assemble the Left Cross Beam (Long Side)(D1) and Right Cross Beam (Long Side)(D2) to post(A) with bolts(H1), tighten by wrench (HW1).

STEP 5

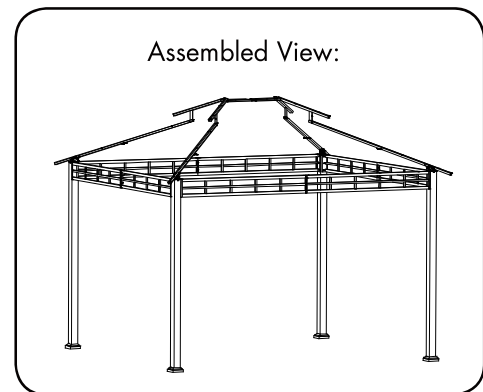
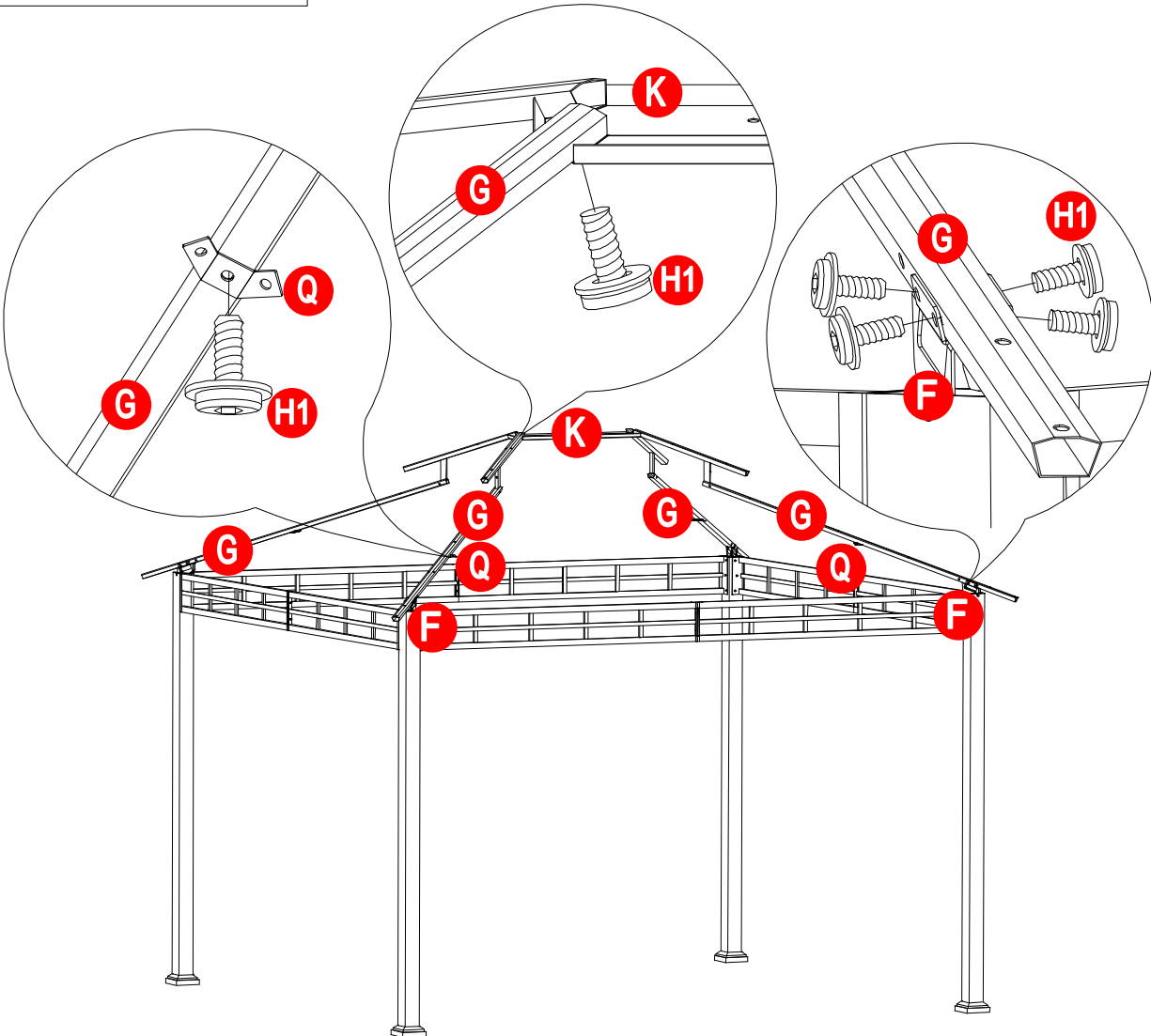
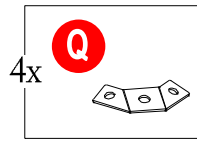
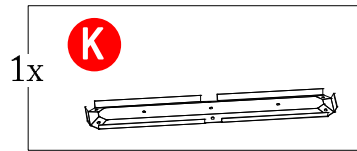
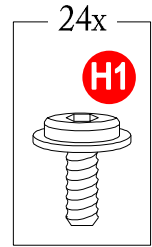
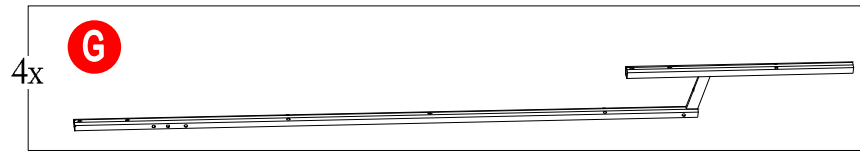

Assemble the Rafter(G) to Small Connector(K) and Rafter Connector(F) with bolts(H1), assemble the Beam Connector 2(Q) to Rafter(G) with bolts(H1), tighten by wrench (HW1).

STEP 6

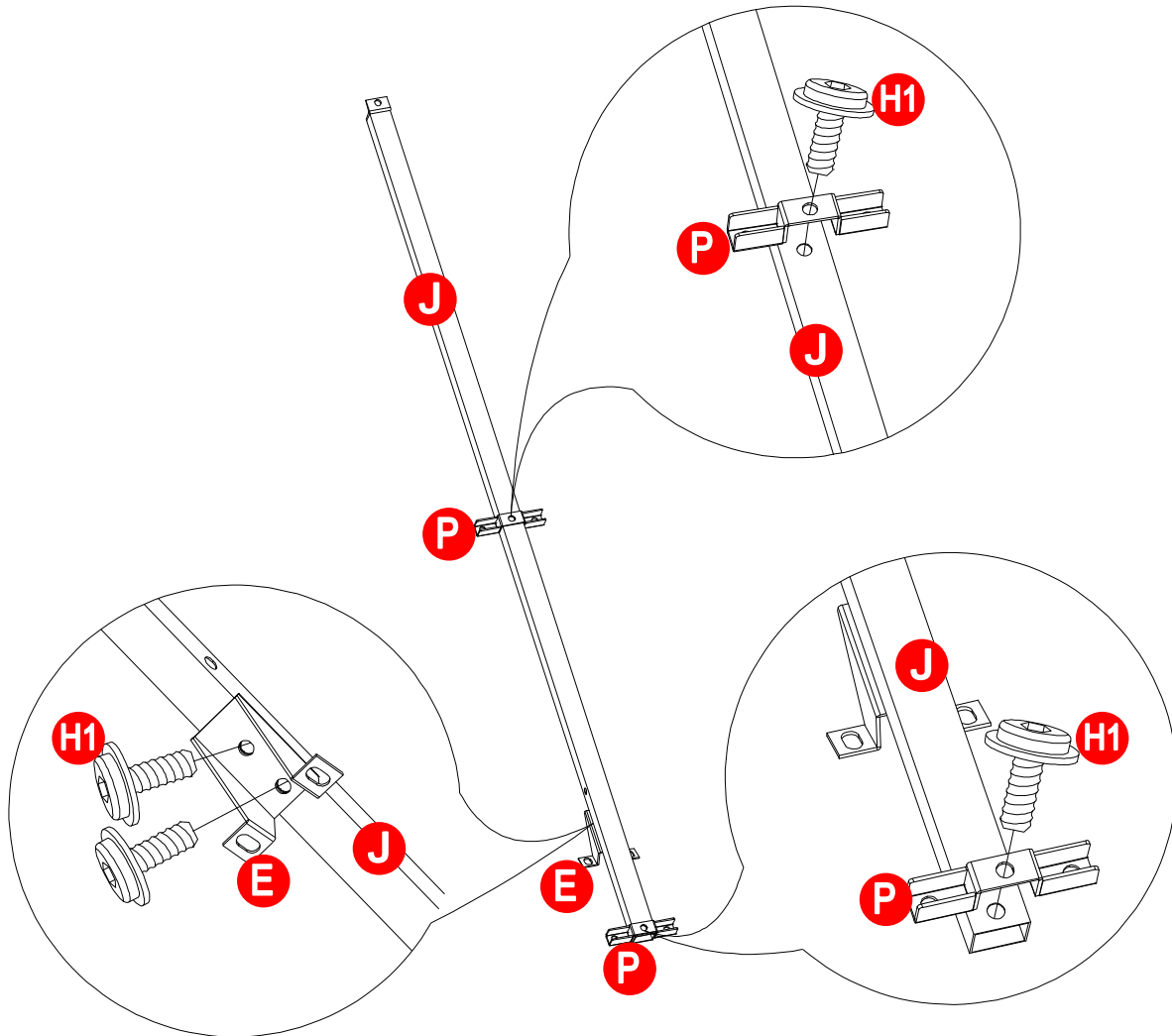
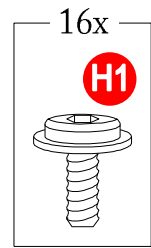
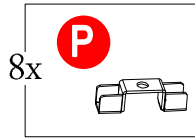
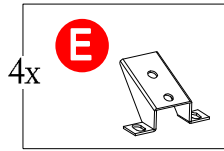
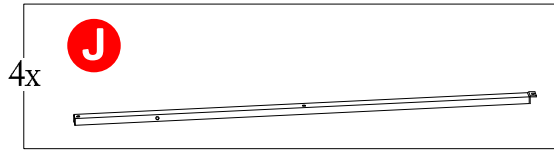

Assemble the Middle Beam Connector(E) and Beam Connector 1(P) to Middle Beam(J) with bolts(H1), tighten by wrench (HW1).

Assembled View:

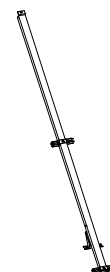

STEP 7

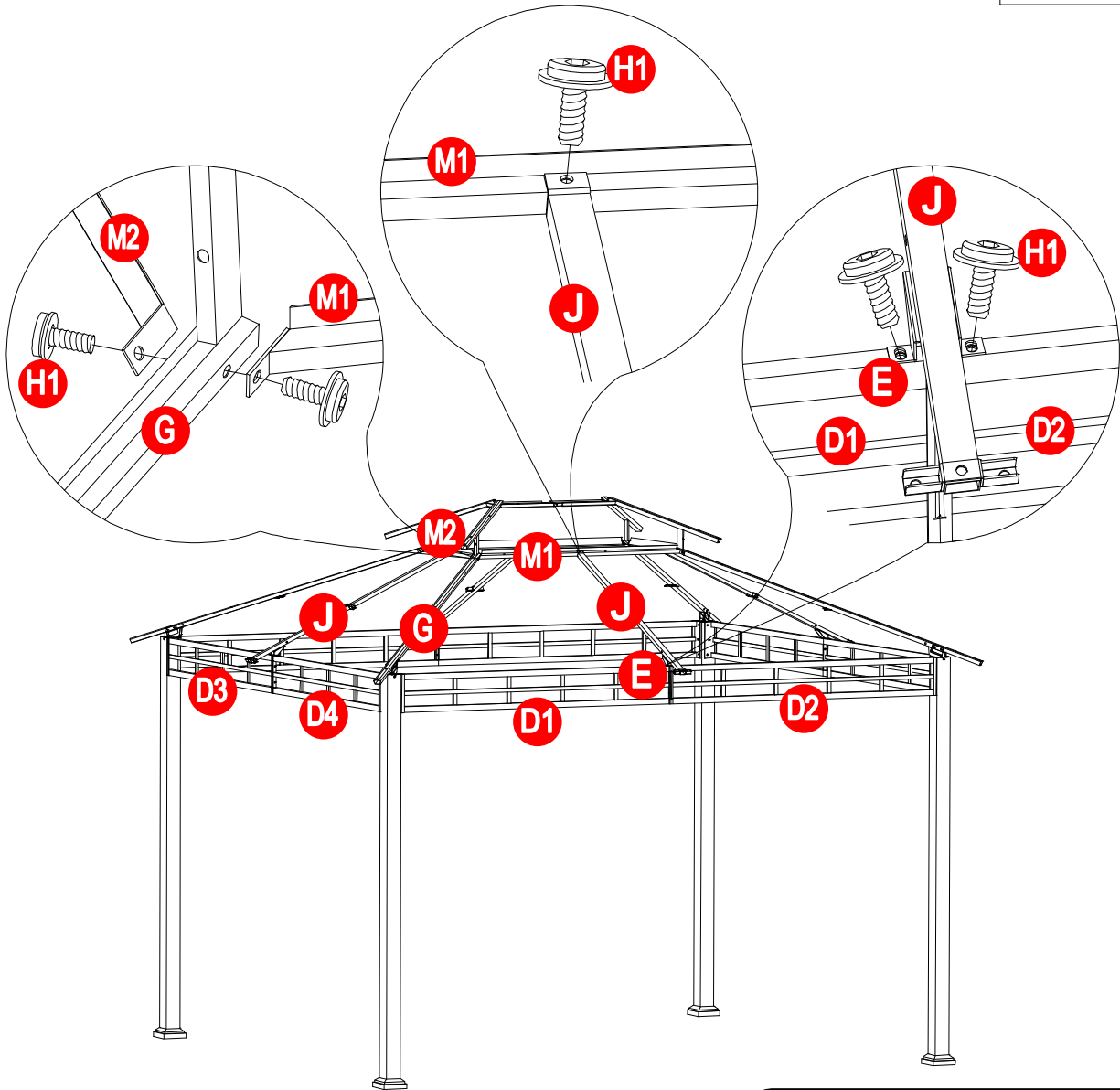
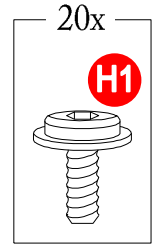
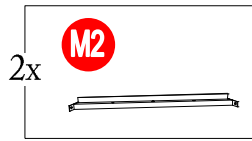
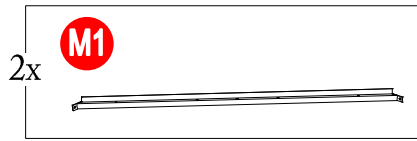

Assemble the Big Roof Up Panel Flashing(M1)&(M2) to Rafter(G) with bolts(H1), assemble the Middle Beam(J) to Big Roof Up Panel Flashing(M1)&(M2) with bolts(H1), assemble the Middle Beam Connector(E) to Cross Beam(D1/D2/ D3/D4) with bolts(H1), tighten by wrench (HW1).

Assembled View:



STEP 8

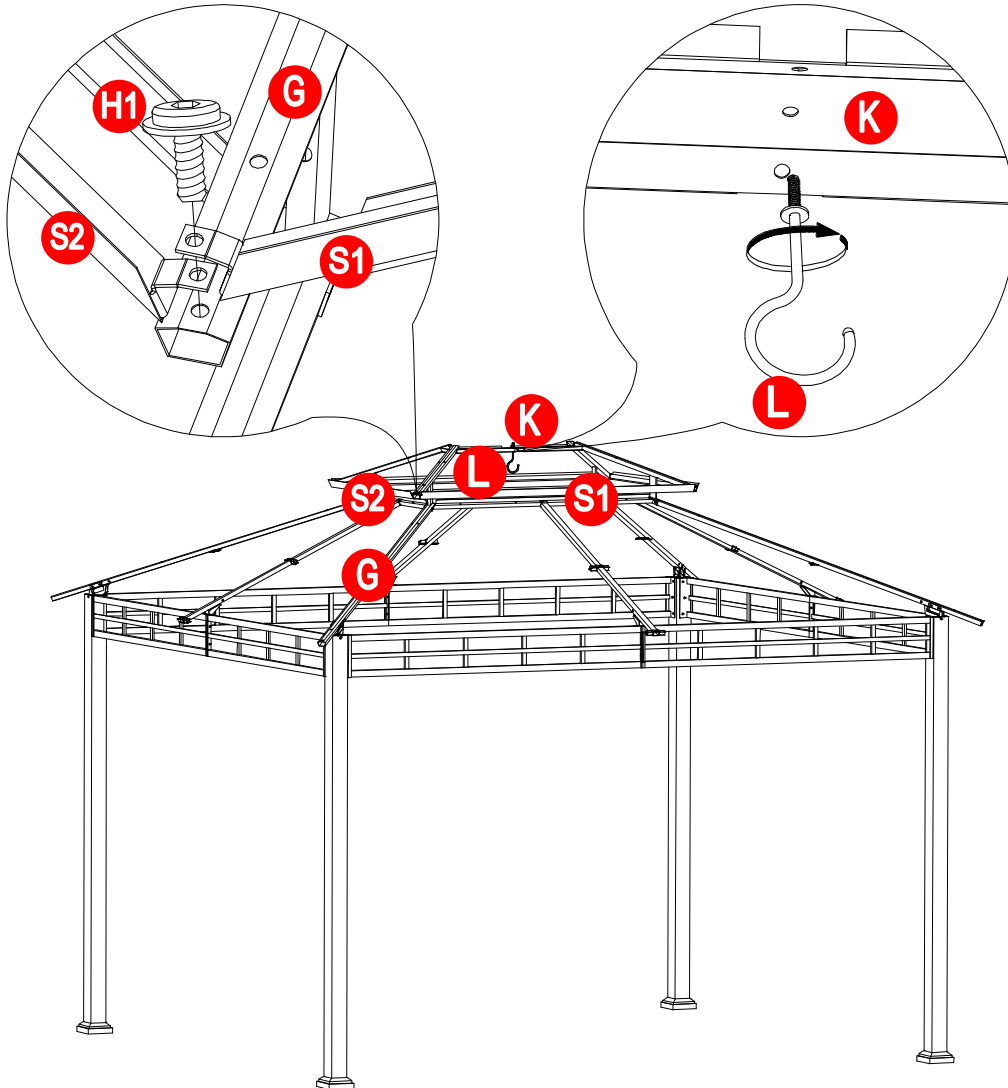
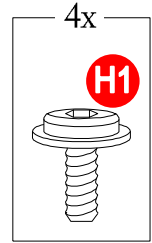
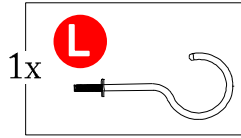
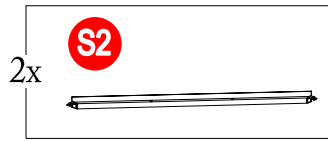
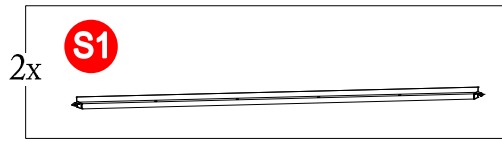

Assemble the Small Roof Low Panel Flashing(S1)&(S2) to Rafter(G) with bolts(H1), tighten by wrench (HW1). Screw the Hook(L) to the Small Connector(K).

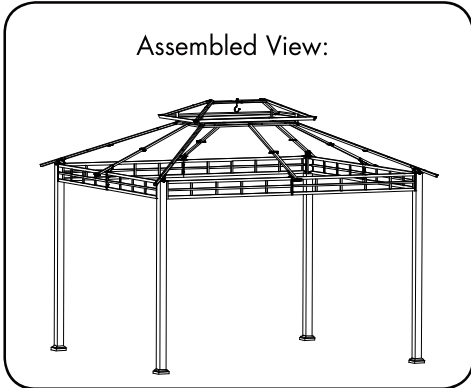

STEP 9

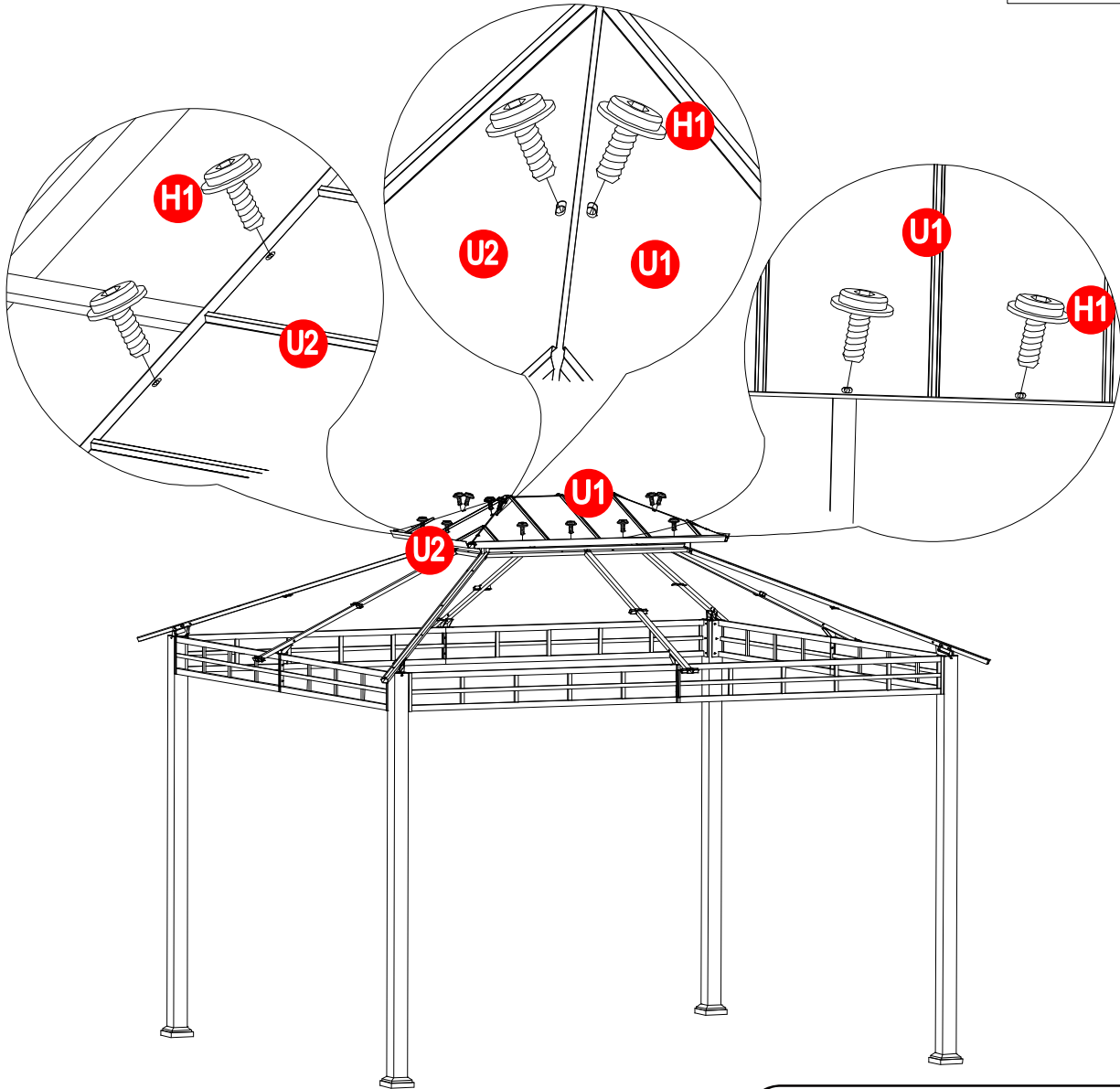
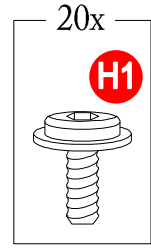
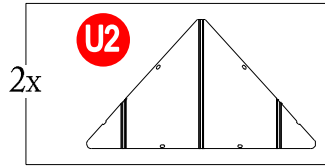
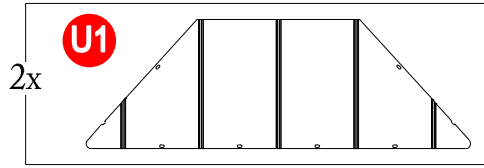

Spread the Small Roof Panel(U1)&(U2) on the small roof, assemble the Small Roof Panel(U1)&(U2) to Rafter(G) with bolts(H1), assemble the Small Roof Panel(U1)&(U2) to Small Roof Low Panel Flashing(S1)&(S2) with bolts(H1), tighten by wrench (HW1).

Assembled View:



STEP 10

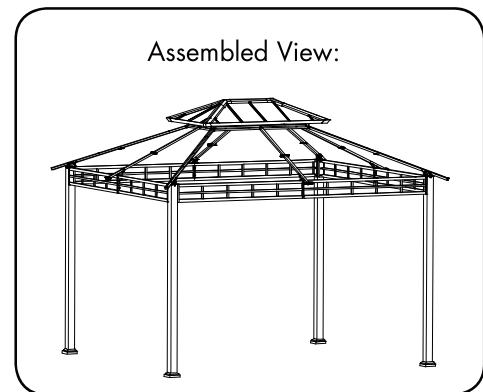
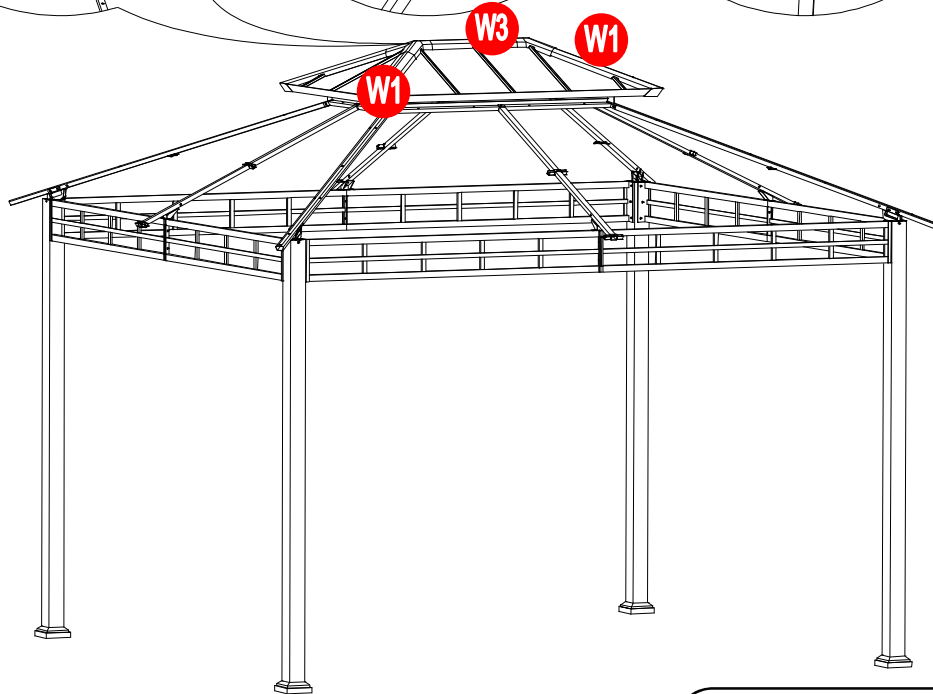
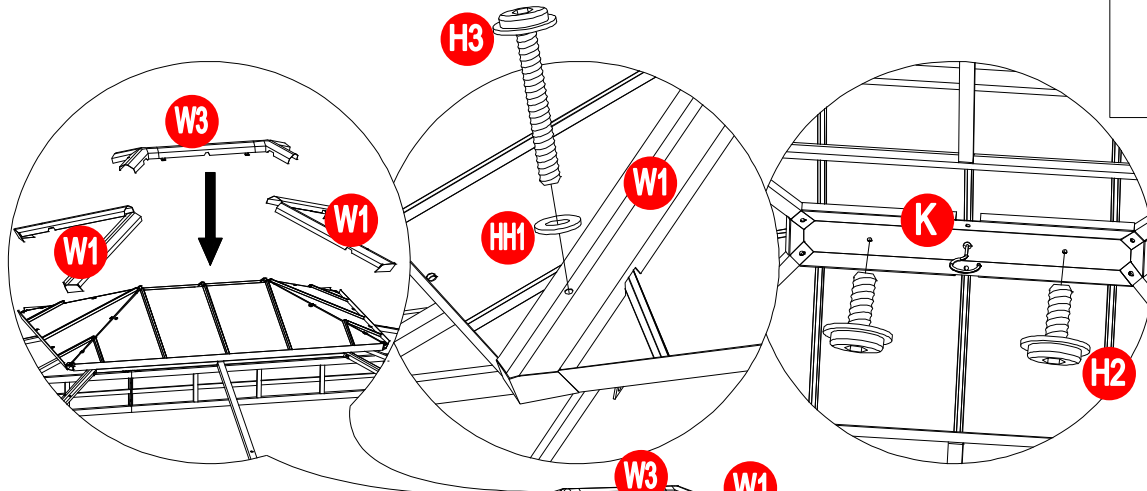
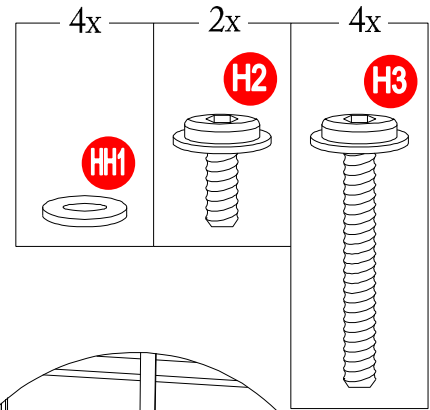
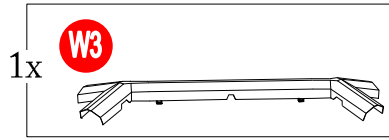
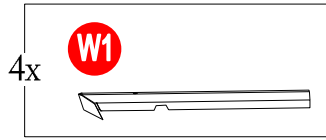

Cover the Small Roof Rafter Cap(W1) and Top Cover(W3) on the small roof, Assemble the Small Roof Rafter Cap(W1) to Rafter(G) with bolts(H3) and rubber(HH1), Assemble the Top Cover(W3) to Small Connector(K) with bolts(H1), tighten by wrench (HW1).

STEP 11

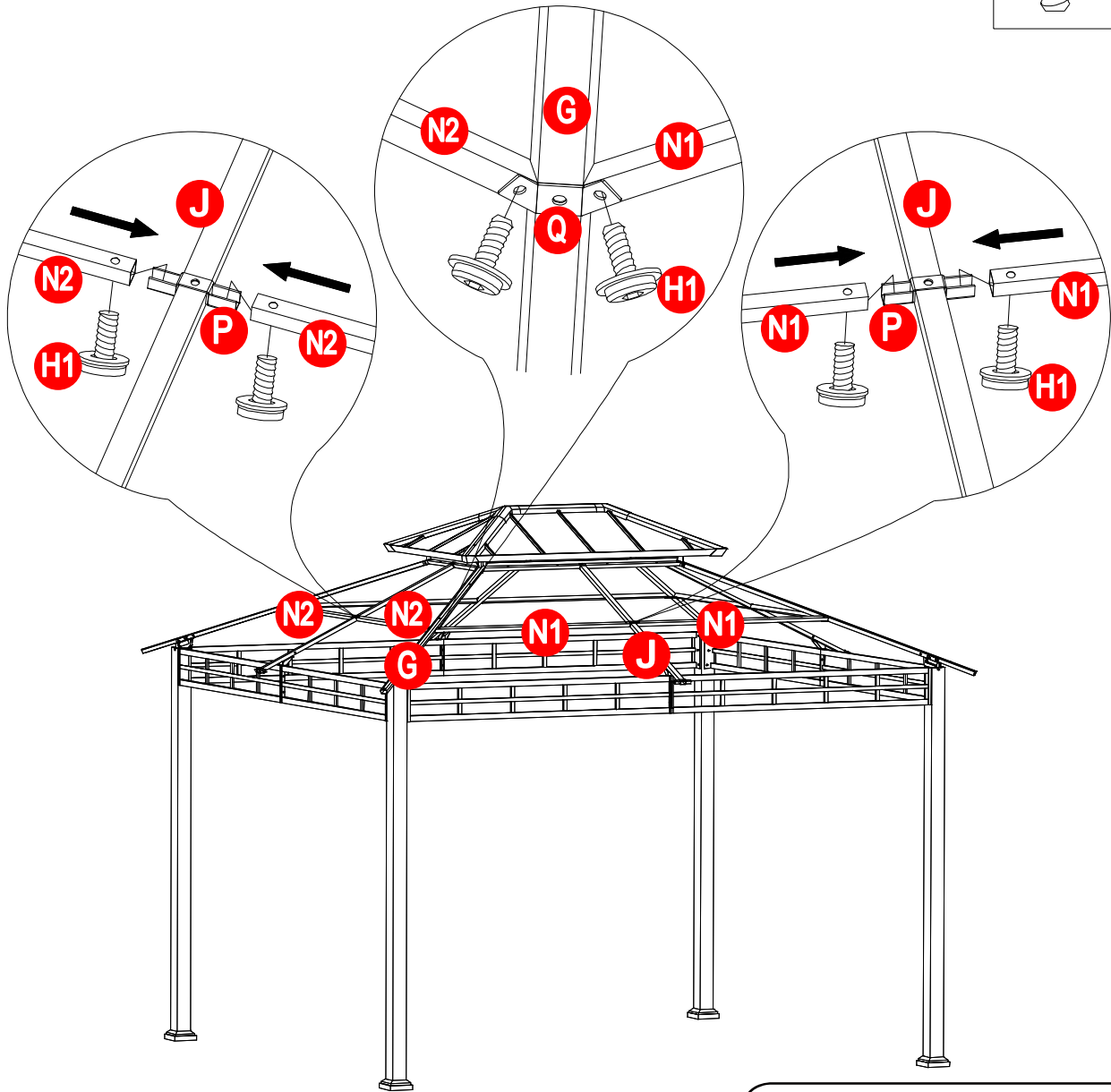
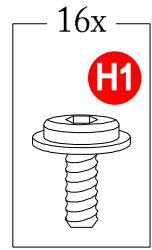
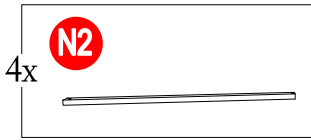
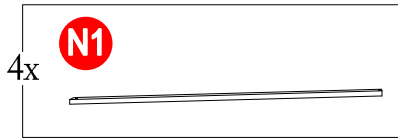

Assemble the Big Roof Small Beam(N1)&(N2) to Beam Connector 1(P) with bolts(H1), Assemble the Big Roof Small Beam(N1)&(N2) to Beam Connector 2(Q) with bolts(H1), tighten by wrench (HW1).

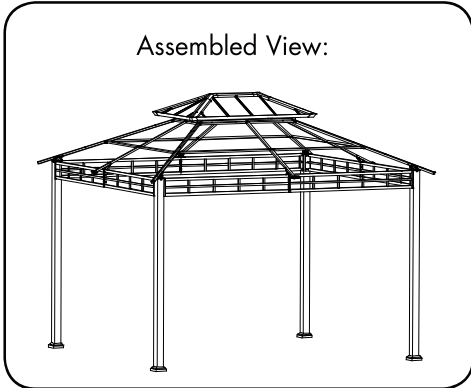

STEP 12

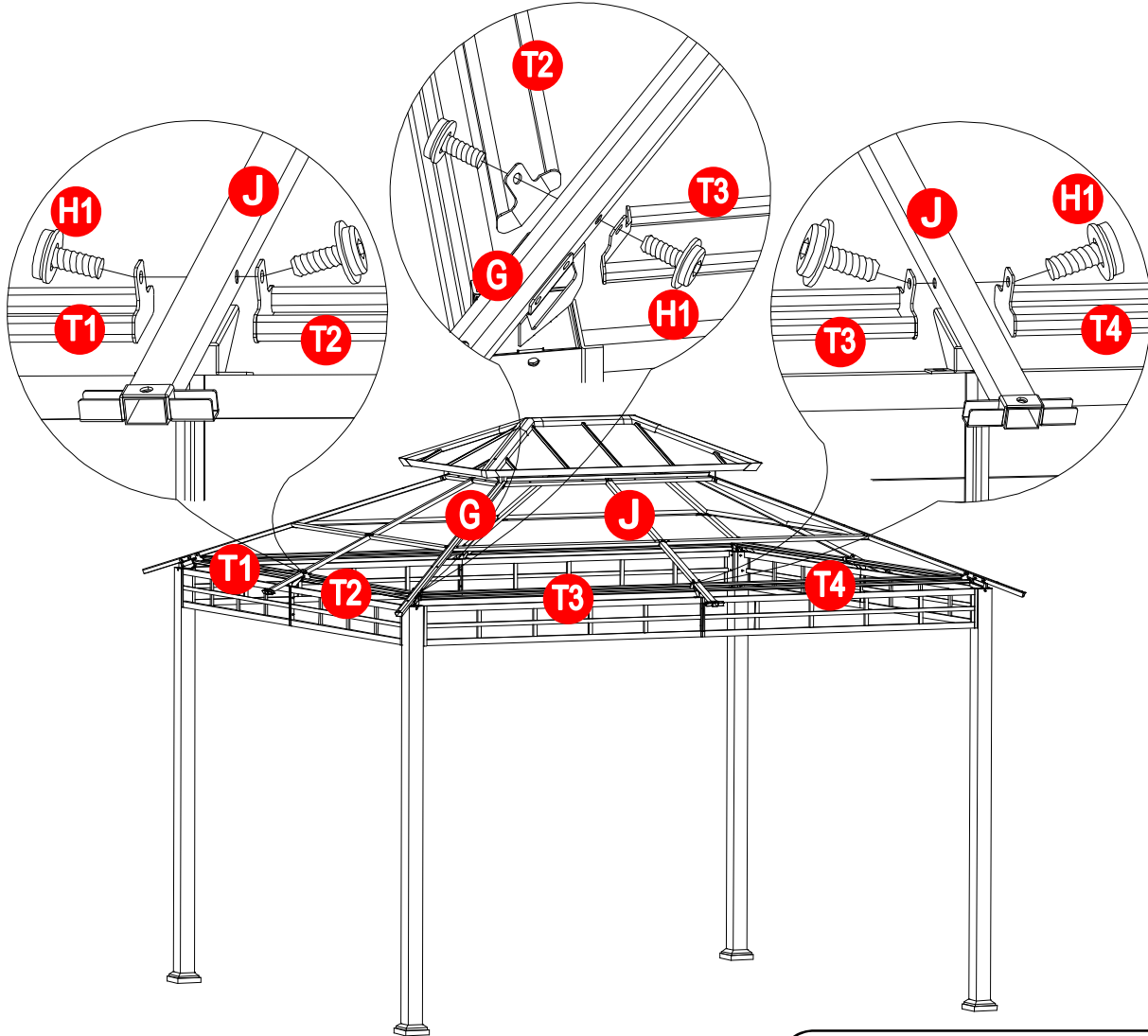
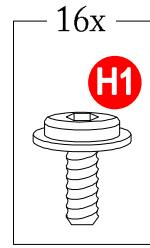
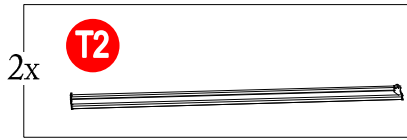

Assemble the Short Mosquito Netting Rod (T1)&(T2) to Middle Beam(J) and Rafter(G) with bolts(H1), Assemble the Long Mosquito Netting Rod(T3)&(T4) to Middle Beam(J) and Rafter(G) with bolts(H1), tighten by wrench (HW1).

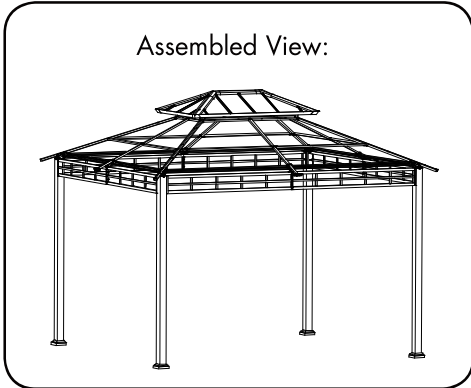

STEP 13

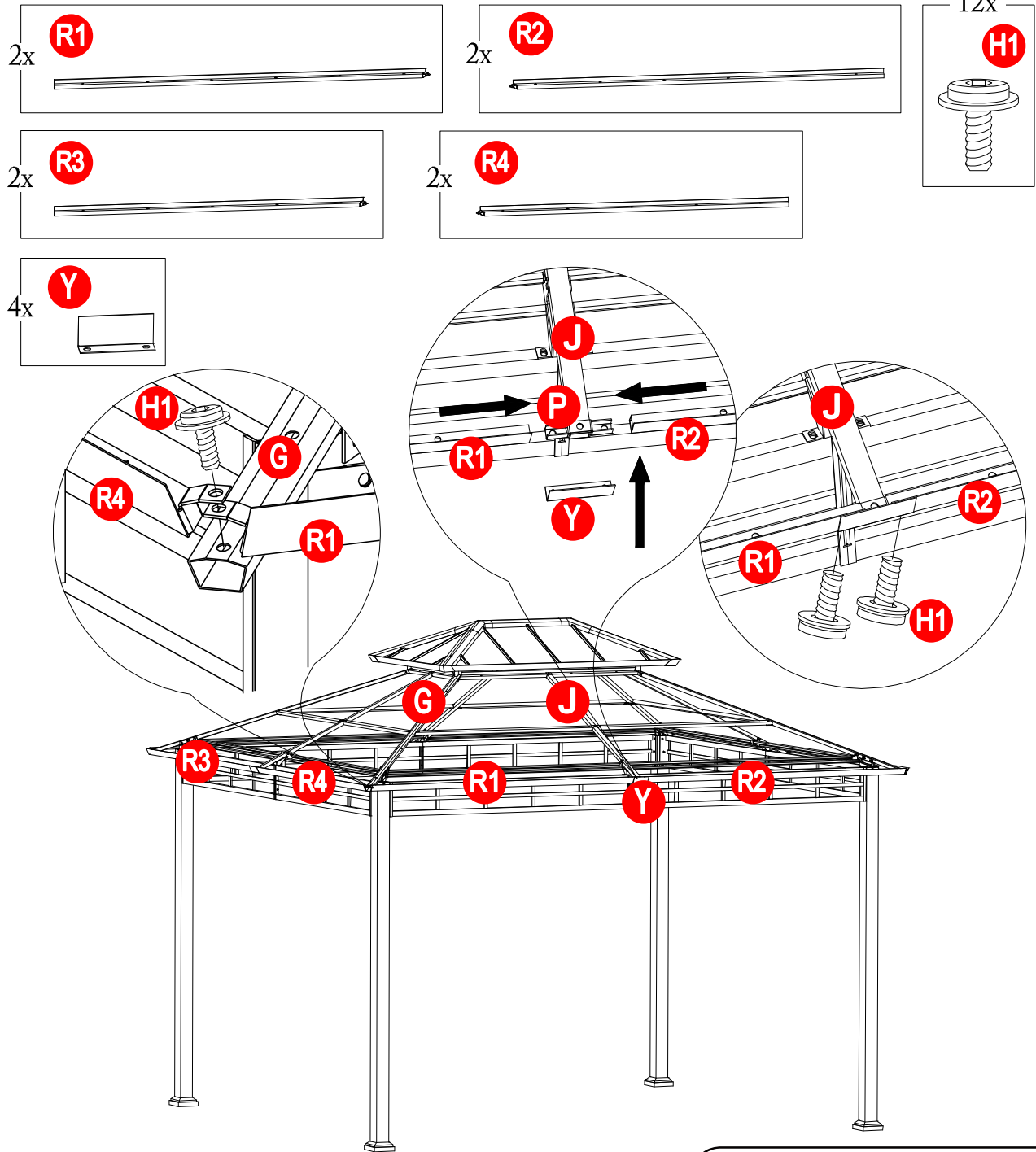

Assemble the Middle Beam Decoration(Y) and Beam Connector 1(P) to Big Roof Panel Flashing (R1/R2/R3/R4) with bolts(H1), Assemble the Rafter(G) to Big Roof Panel Flashing (R1/R2/R3/R4) with bolts(H1), tighten by wrench (HW1).

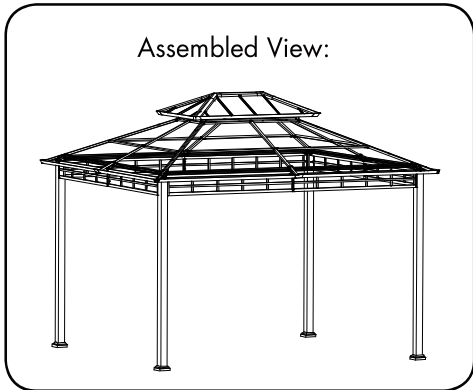

STEP 14

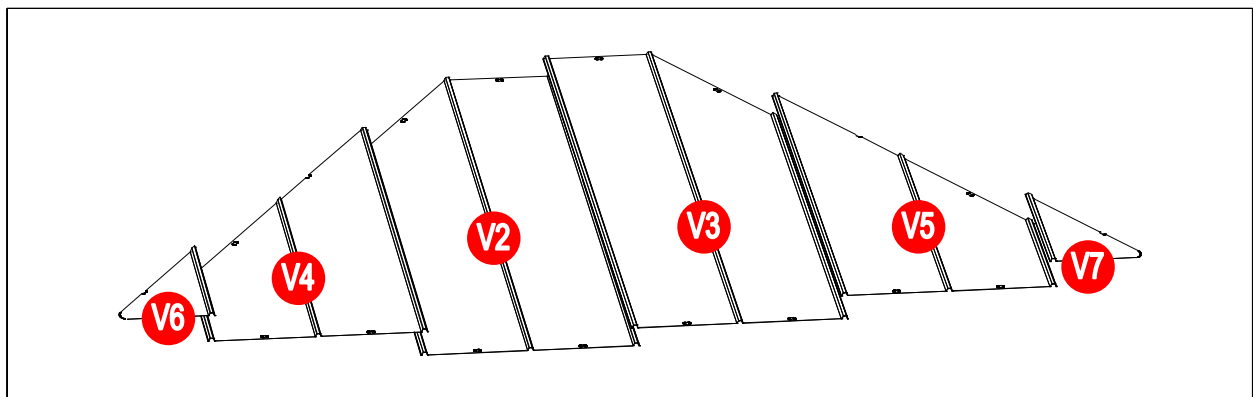
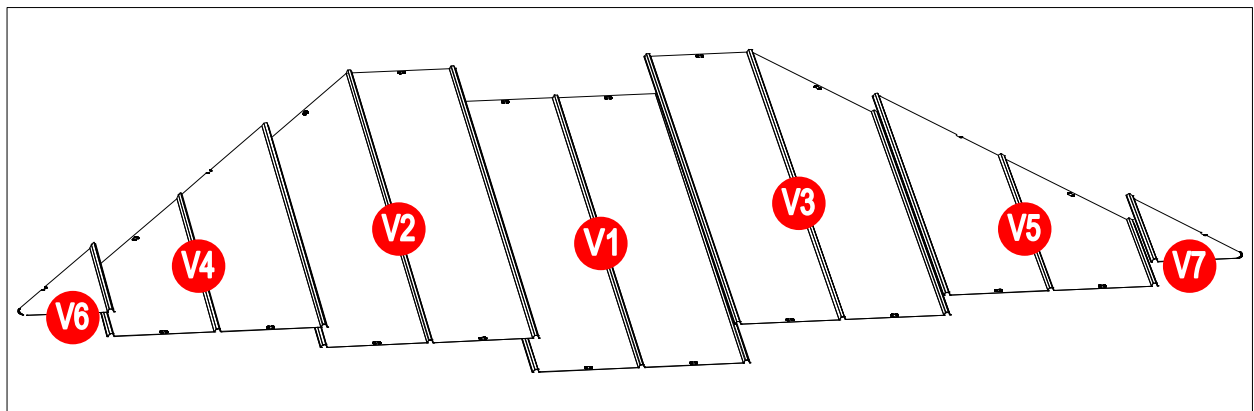
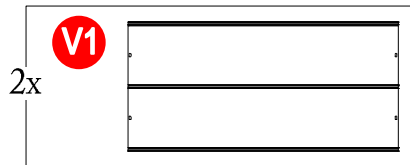
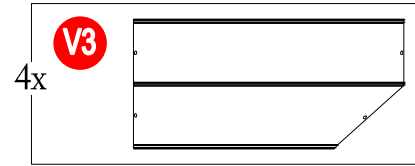
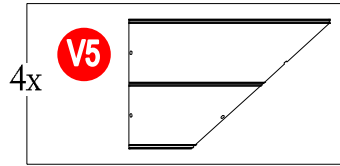
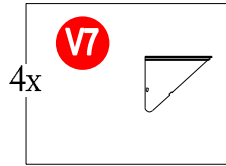
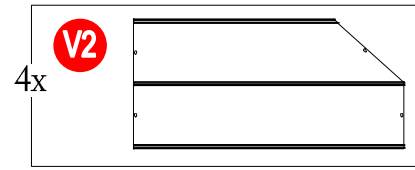
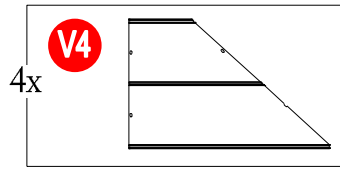
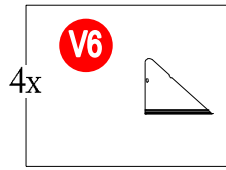

As shown in the picture, spread the Big Roof Panel (V1/V2/V3/V4/V5/V6/V7) on the long side of big roof, spread the Big Roof Panel (V2/V3/V4/V5/V6/V7) on the short side of big roof.

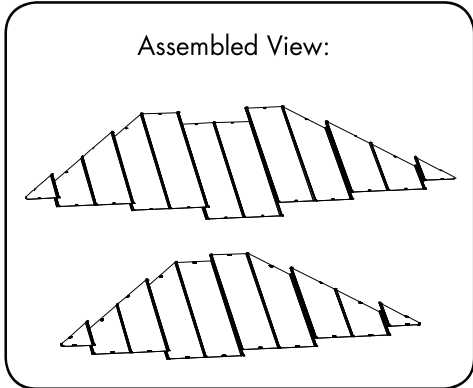

STEP 15

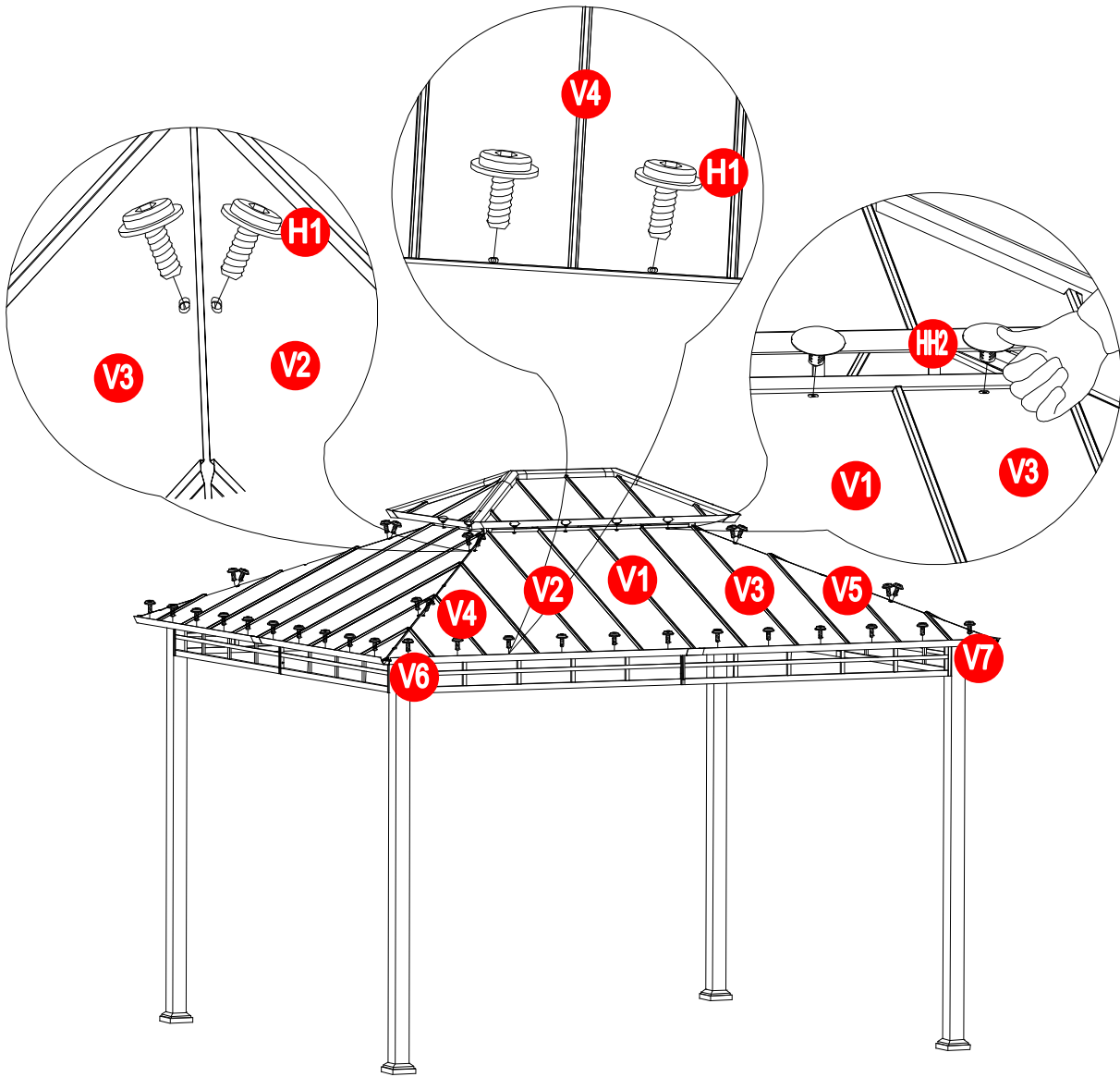
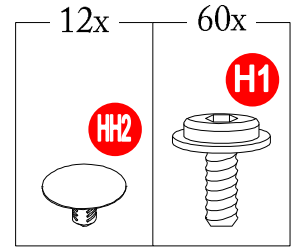

Lock the Big Roof Panel (V1/V2/V3/V4/V5/V6/V7) to the Big Roof Up Panel Flashing(M1)& (M2) ,Rafter(G) and Big Roof Long Panel Flashing(R1/R2/R3/R4) with Plastic Buckle(HH2) and bolts(H1), tighten by wrench (HW1).

Assembled View:



STEP 16

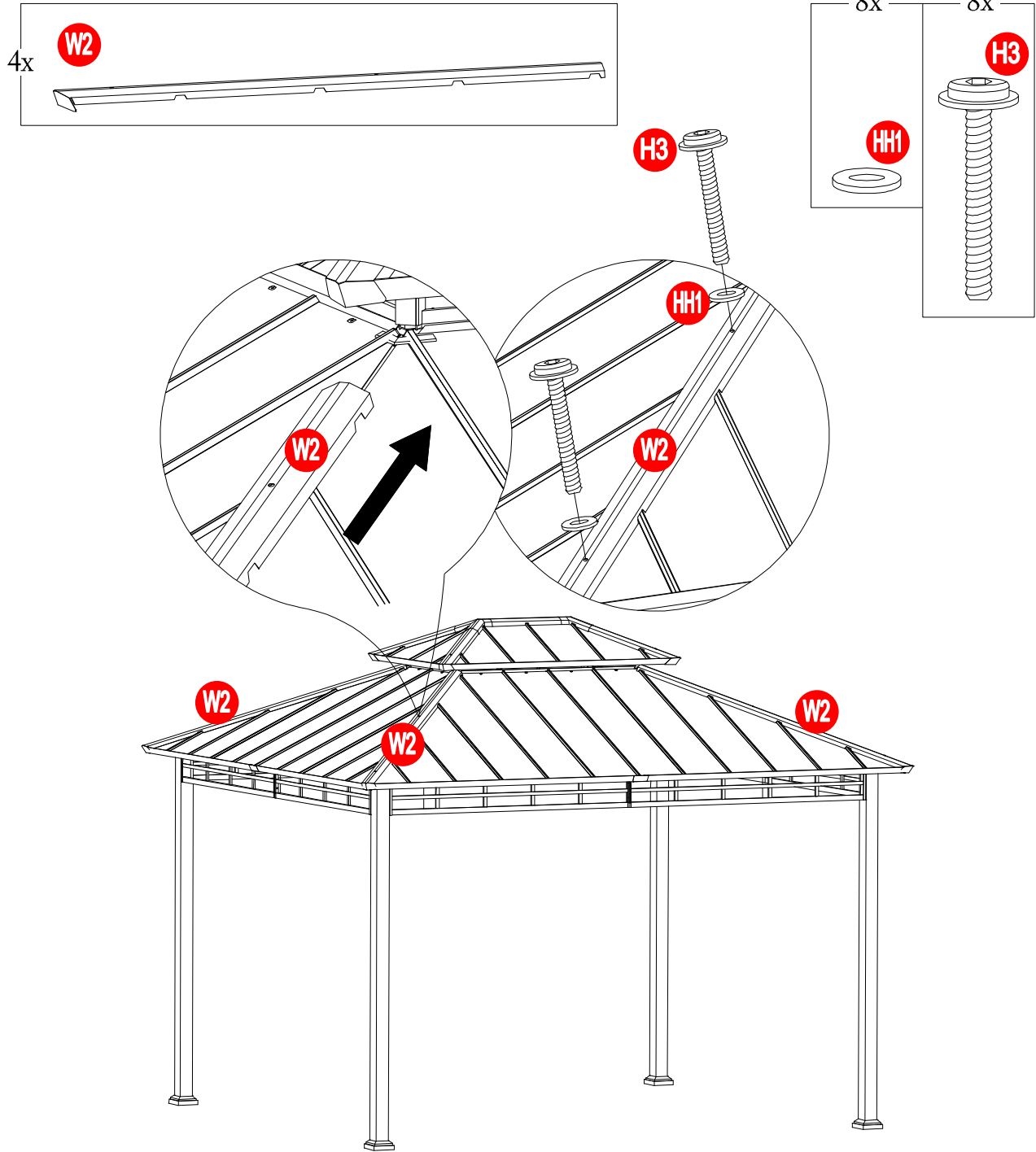

Assemble the Big Roof Rafter Cap(W2) to Rafter(G) with bolts(H3) and washer(HH1), tighten by wrench (HW1).

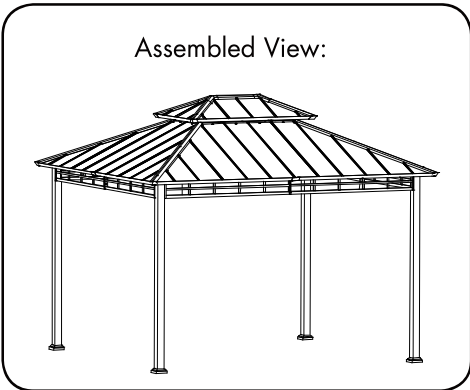

STEP 17

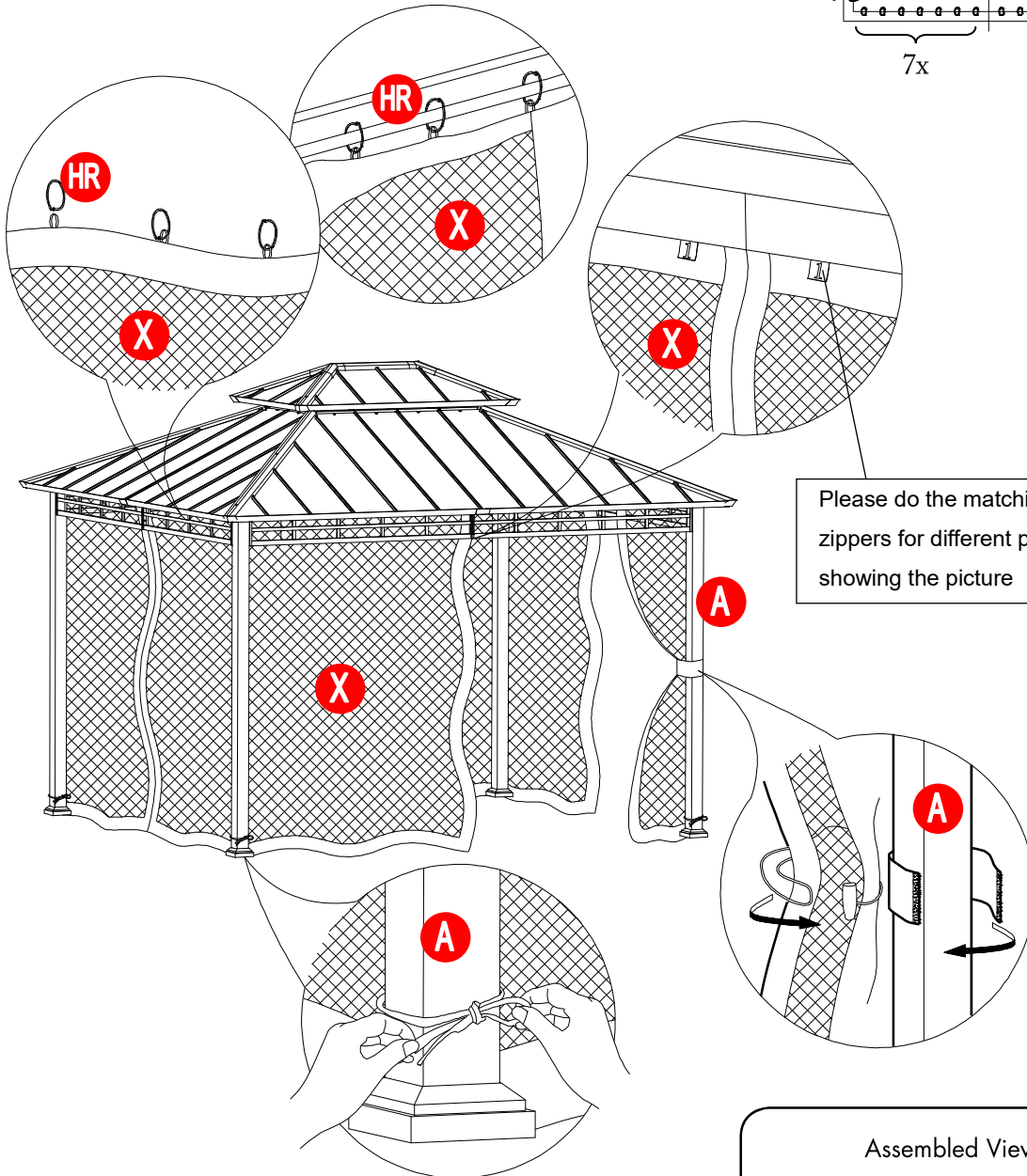
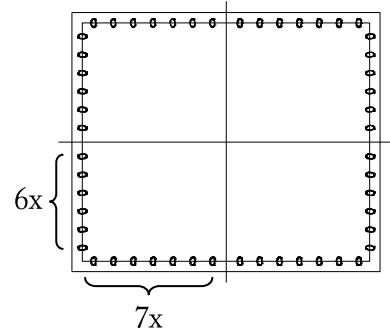
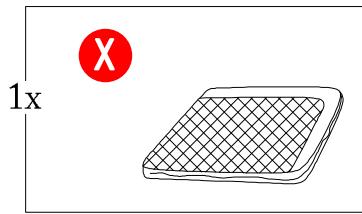

Please do the matching of zippers for different panels as showing the picture

Hang the Mosquito Netting(X) on the Mosquito Netting Rod (T1/ T2/T3/T4) with Ring(HR), banding the netting to the Post(A) with Velcro and rope.

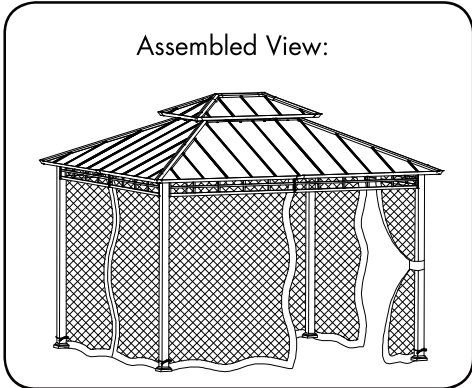

STEP 18

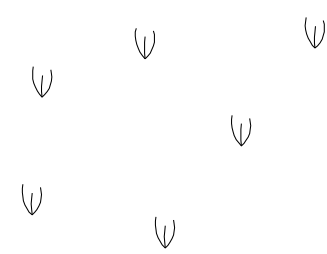
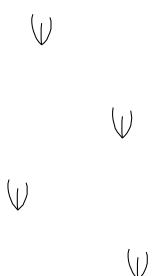
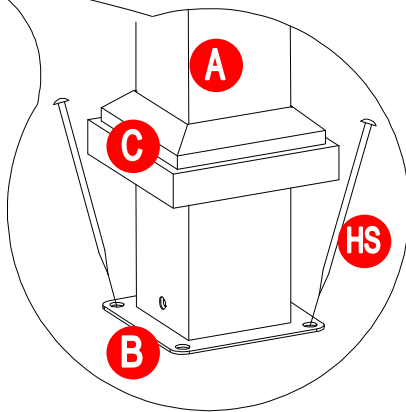
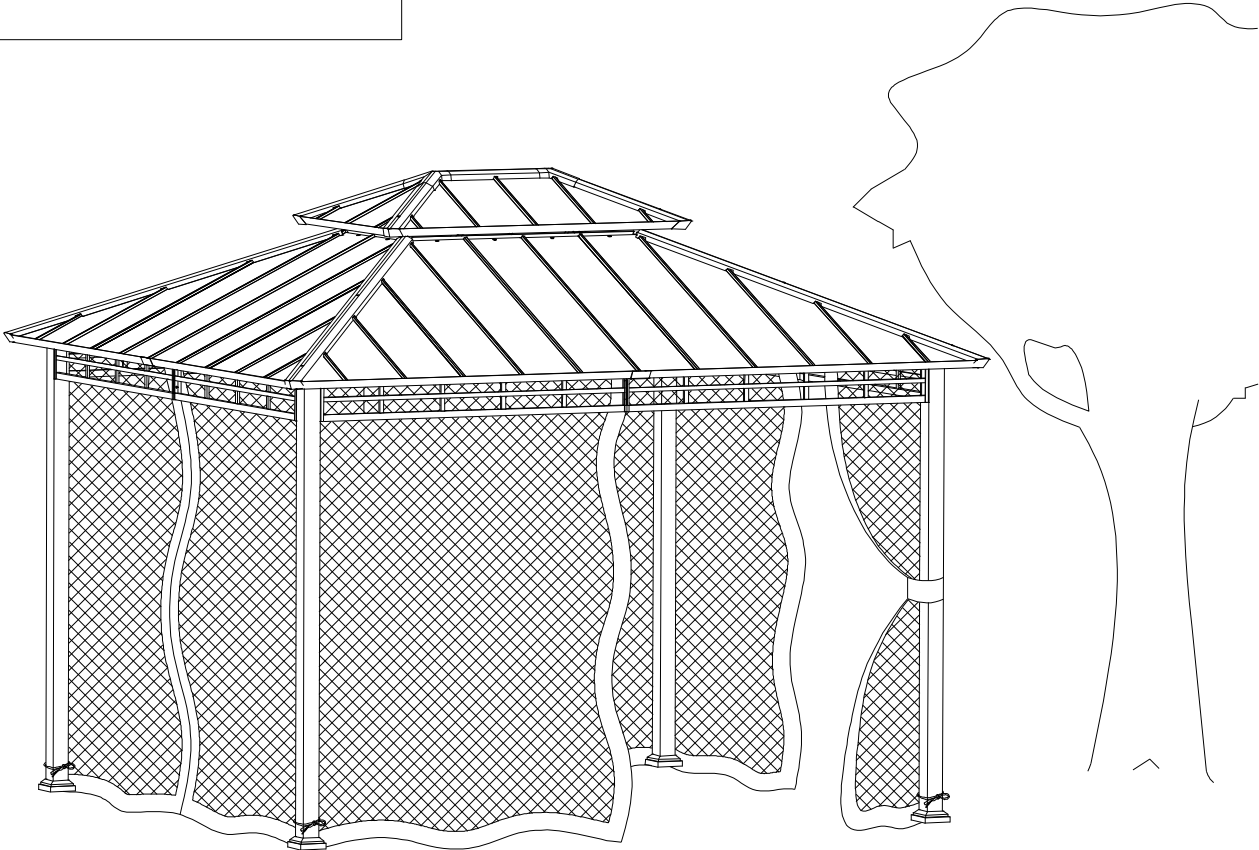
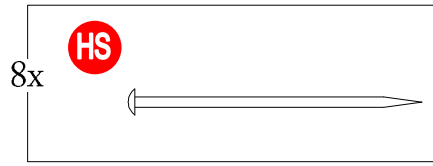

Use Stake (HS) to fix the assembled tent on the flat ground through the Post Base (B), and the product assembly is completed.

