

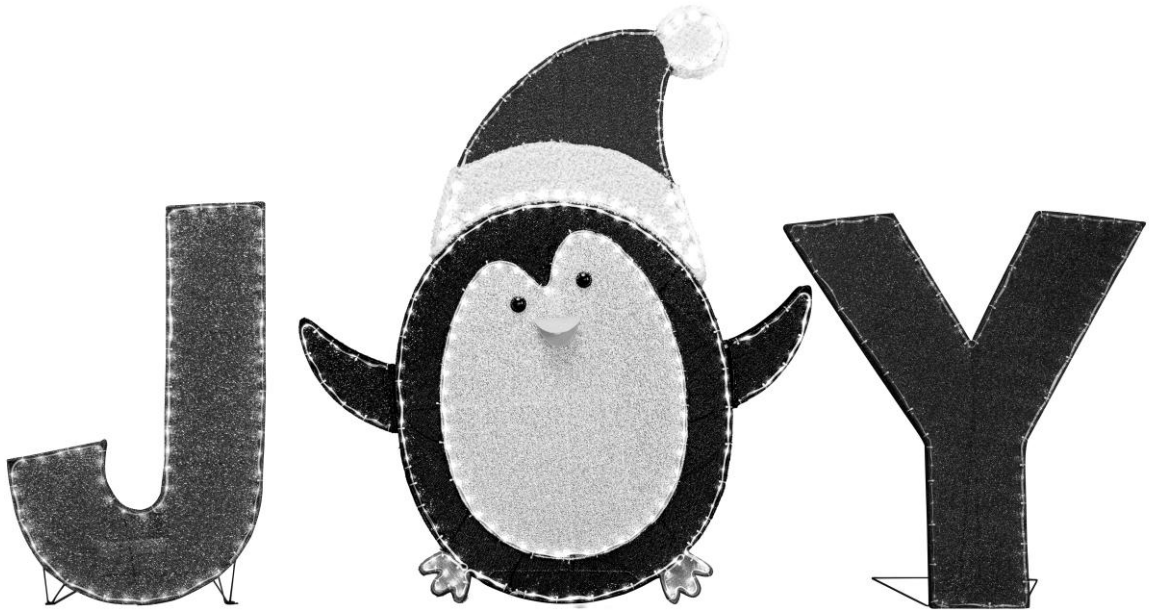





JOY Penguin Sign

Operation and Safety Instructions

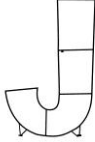

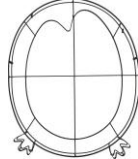
- FOR INDOOR AND OUTDOOR USE -

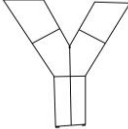
PARTS:

Part	Description	Illustration	Qty
A	J		1
B	Green Stake		1
C	Hat		1
D	Body		1
E	Wings		2
F	White Stake		1
G	Y		1
H	Red Stake		1
I	Plastic Ties		8

J	Ground Stakes		6
---	---------------	--	---

To Assemble

1. Remove all the parts from the box carefully and lay out the components.
2. Insert the prongs of the Green stake (B) into the corresponding rings on the J (A).

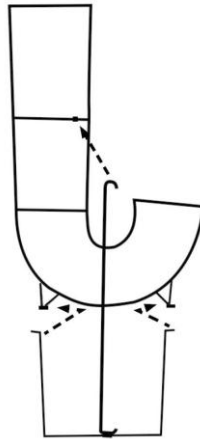

3. Insert the prongs of the Hat (C) and the Wings (E) into the corresponding rings on the Body (D).

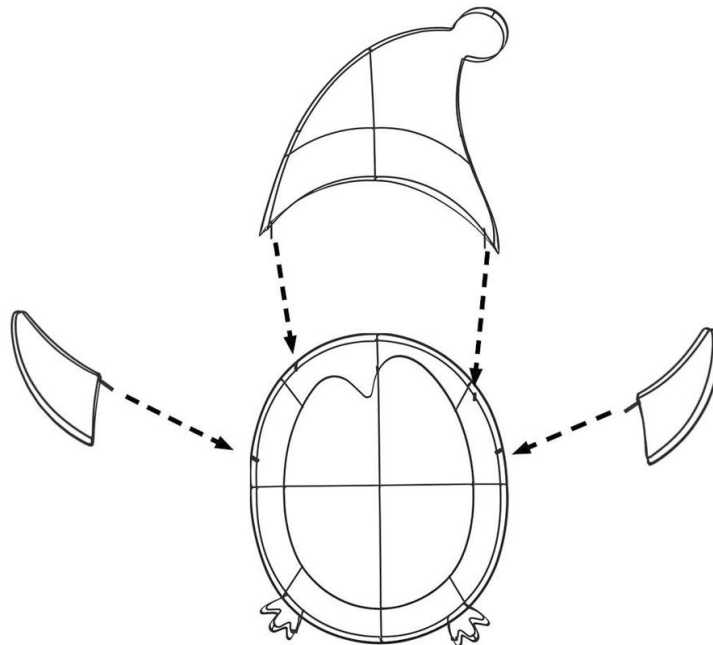

4. Insert the prongs of the White stake (F) into the corresponding rings on the Body (D).

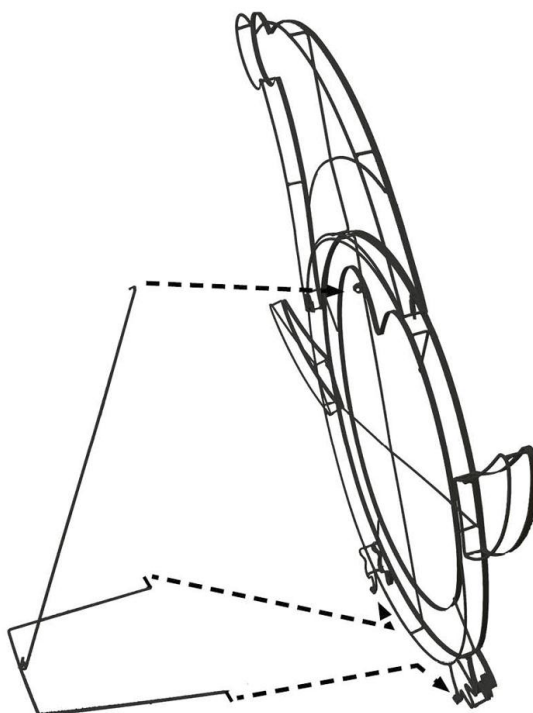

5. Insert the prongs of the Red stake (G) into the corresponding rings on the Y (H).

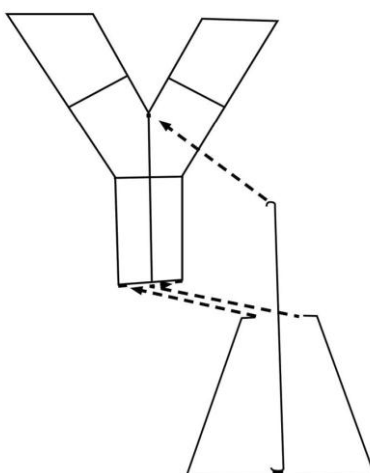

6. Secure the installing points with plastic ties and secure the base to the soft ground by fully inserting 6 stakes into the ground.

To Use

1. To illuminate, plug the adaptor into a standard 120-volt AC electrical outlet.
2. To shut off, unplug the power cord from the outlet.

Distributed By:
Big Lots Stores, Inc.
PO Box 28523
Columbus, OH
43228-0523