



 **real**
living™

ARROW RIDGE
4PC SWIVEL DINING CHAIRS

ASSEMBLY INSTRUCTION

ITEM#: H21SR016VS
SKU# 810589367

Need help? We are here for you! 1(877)800 – 6021 • Toll Free
service@hccipatio.com • Email Address

GENERAL BEST PRACTICES FOR ASSEMBLY:

Read all instructions before starting

Clear a flat covered space to begin assembly

Always best to do it with a friend

Note that hardware required is provided for every step

Pay attention to orientation

Letter of the part corresponds to a sticker on the product

Number of the hardware corresponds to its letter in the package

Helpful hints provided along the way

Retain these assembly instructions for future reference

WARNINGS:

Regularly check hardware and tighten if necessary

Use the correct bolts as indicated. Do not tighten any of the bolts until the chair is completely assembled.

Do not discard any of the packaging until you have checked that you have all of the parts and fittings required.

Keep children away during assembly. This item contains small parts that can be swallowed by children.

Children should always be under direct adult supervision while using this product.

Chair is for sitting purposes only. Standing on or misuse of chair may result in damage or injury.

Not intended for commercial use. Weight limit is 250 lbs (113.5 kg).

MAINTENANCE:

Wash frame and fabric parts with mild soap and water, rinse thoroughly, and dry completely. Do not use bleach, acid, or other solvents on the frame or fabric parts.







The cushions may be washed on the surface only by using mild soap and water or a commercial foaming upholstery cleaner if necessary. If washed, rinse well and hang to dry. Do not machine wash or dry.







We recommend the use of furniture covers when not in use.

Inspect and tighten all of the bolts and fasteners on a regular basis to ensure the proper performance and safety of your chair.

In order to prolong the life and beauty of your chair, we recommend that it be stored in a dry and protected area during off season periods.

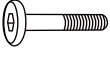
PARTS LIST

PART NO.	MATERIAL CODE	PART	Q'TY
1	HRVS030S-BB	 BACK ASSEMBLY	1
2	HRVS030S-ZB	 SEAT ASSEMBLY	1
3	HRVS030S-ZSB	 LEFT ARM	1
4	HRVS030S-YSB	 RIGHT ARM	1
5	HRVS030S-ZG	 SEAT POST	1
6	HRVS030S-DZ	 BASE ASSEMBLY	1
7	HRVS030S-ZSG	 DECORATIVE PLASTIC COVER	1

PART NO.	MATERIAL CODE	PART	Q'TY
8	LS-M6-15	 BOLT M6*15	6
9	LS-M6-35	 BOLT M6*35	5
10	LS-M6-45	 BOLT M6*45	2
11	DP-d6.5-D13	 WASHER d6.5*D13*1.0	12
12	DP-d6.5-D14	 WASHER d6.5*D14*1.0	2
13	DP-d6.5-D30	 WASHER d6.5*D30*2.0	1
14	HRVS030S-ZM	 SEAT CUSHION	1

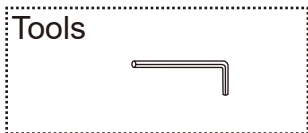

STEP 1

PARTS REQUIRED: 1, 2, 10, 11, & 12
Keep the bolts loose.

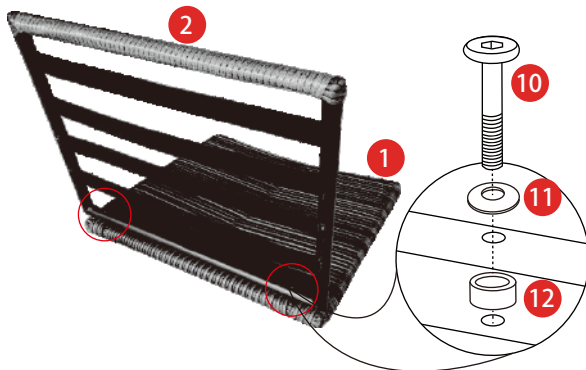
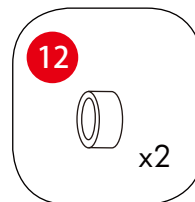
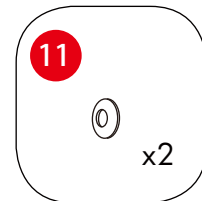
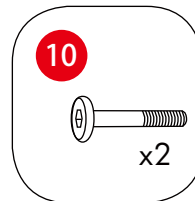

STEP 2

PARTS REQUIRED: 2, 3, 4, 9, & 11
Keep the bolts loose.

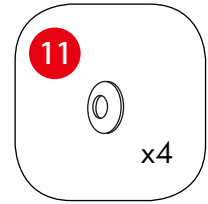
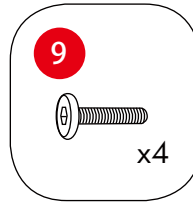
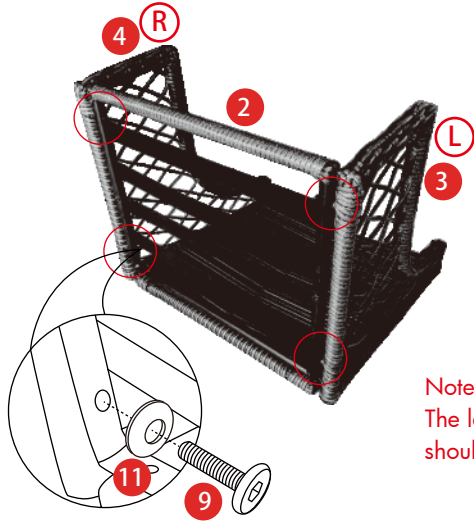

Note:
The labels marked "L" and "R" on the arms (#3 and #4)
should coincide with Step 2 to ensure proper assembly.

STEP 3

PARTS REQUIRED: 1, 3, 4, 8, & 11
Tighten all bolts by using the supplied Hex key.

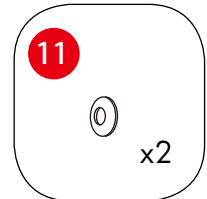
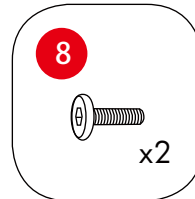
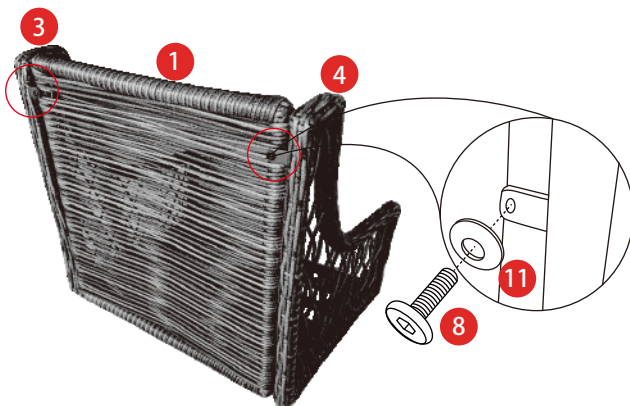

STEP 4

PARTS REQUIRED: 2, 5, 8, & 11

Tighten all bolts by using the supplied Hex key.

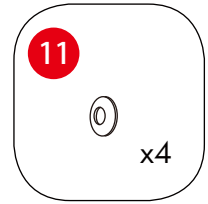
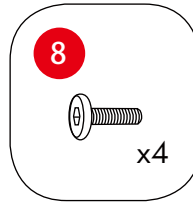
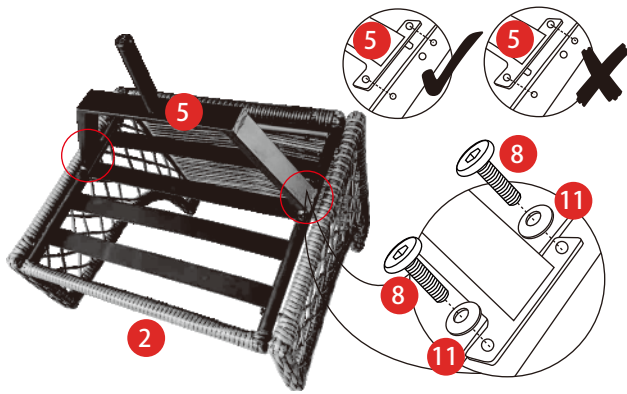

STEP 5

PARTS REQUIRED: 6, & 7

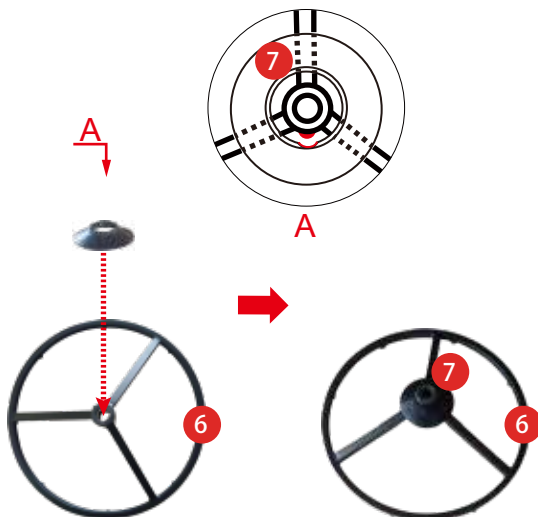
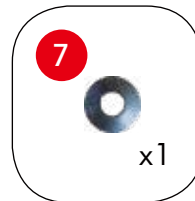

STEP 6

PARTS REQUIRED: 5, 6, 9, & 13
Tighten all bolts by using the supplied Hex key.

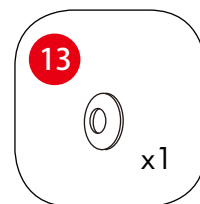
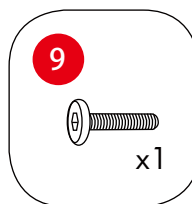
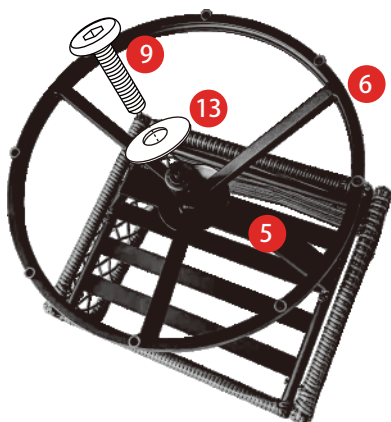

Note:
For ease with installation, we recommend that the seat post (#5) be slightly oiled or waxed before fastening it to the base assembly (#6).

STEP 7

PARTS REQUIRED: 14



Caution:
To ensure one's safety during use of this swivel chair, examine all of the bolts to make sure that they are securely fastened. This is a chair with swivel ability; therefore, use by young children should be adult supervised.

Warranty

- One-year limited warranty.
- Proof of purchase (dated register receipt) is required for warranty claims.
- It remains the customer's responsibility for freight and packing charges to and from the service center.

STOP!

Missing A Part? No Need To Go Back To The Store

The store where you made your purchase does not stock parts for this item.
If you need parts, whether they are missing or damaged,

Call Toll Free:

TEL: 1-877-800-6021

Call us between 9:00 AM and 4:30 PM Eastern Time Monday through Friday
For further assistance, please visit us at service@hcupatio.com