



ASSEMBLY INSTRUCTION

ITEM#: H22SK1511-1

SKU#: 810588254

PEMBROKE ARMLESS SOFA CHAIR

Need help? We are here for you!

1 (877) 800 – 6021

• Toll Free

service@hccipatio.com • Email Address

GENERAL BEST PRACTICES FOR ASSEMBLY:

To Ensure Alignment & Easy Assembly, Secure All Bolts & Washers In Place Before Fully Tightening

Read all instructions before starting

Clear a flat covered space to begin assembly

Always best to do it with a friend

Note that hardware required is provided for every step

Pay attention to orientation

Letter of the part corresponds to a sticker on the product

Number of the hardware corresponds to its letter in the package

Helpful hints provided along the way

Retain these assembly instructions for future reference

WARNINGS:

Regularly check hardware and tighten if necessary

Use the correct bolts as indicated. Do not tighten any of the bolts until the chair is completely assembled.

Do not discard of any of the packaging until you have checked that you have all of the parts and fittings required.

Keep children away during assembly. This item contains small parts that can be swallowed by children.

Children should always be under direct adult supervision while using this product.

Loveseat is for sitting purposes only. Standing on or misuse of loveseat may result in damage or injury.

Not intended for commercial use. Weight limit is 250 lbs (113.5 kg).

MAINTENANCE:

Wash frame and fabric parts with mild soap and water, rinse thoroughly, and dry completely. Do not use bleach, acid, or other solvents on the frame or fabric parts.

The cushions may be washed on the surface only by using mild soap and water or a commercial foaming upholstery cleaner if necessary. If washed, rinse well and hang to dry. Do not machine wash or dry.





We recommend the use of furniture covers when not in use.





Inspect and tighten all of the bolts and fasteners on a regular basis to ensure the proper performance and safety of your chair.

In order to prolong the life and beauty of your chair, we recommend that it be stored in a dry and protected area during off season periods.

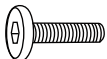
HKVS9150

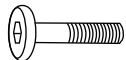
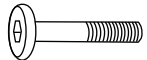
PARTS LIST

PART NO.	MATERIAL CODE	PART	Q'TY
1	HKVS9150-BG	 BACK ASSEMBLY	1
2	HKVS9150-ZG	 SEAT ASSEMBLY	1
3	HKVS9150-ZZG	 SUPPORT	2
4	HKVS9150-JD	 LEG CAP	4
5	LS-M6-35	 BOLT M6*35	4

6	LS-M6-45	 BOLT M6*45	12
7	LS-M6-50	 BOLT M6*50	2
8	DP-d6.5-D13	 WASHER d6.5*D13*1.0	24
9	LM-M6	 JAM NUT M6*1.0	6
10	HKVS9150-BM	 BACK CUSHION	1
11	HKVS9150-ZM	 SEAT CUSHION	1

Tools



STEP 1

PARTS REQUIRED: 2, 3, 5, & 8
Keep the bolts loose.

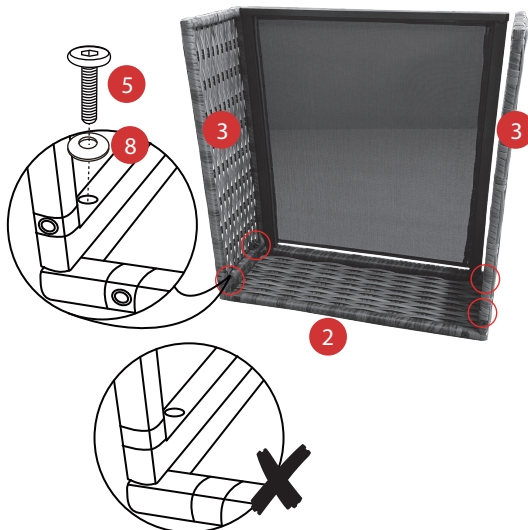
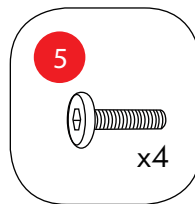

STEP 2

PARTS REQUIRED: 1, 2, 7, 8, & 9
Keep the bolts loose.

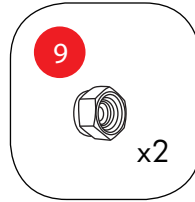
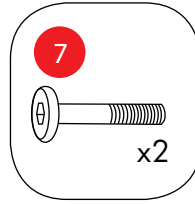
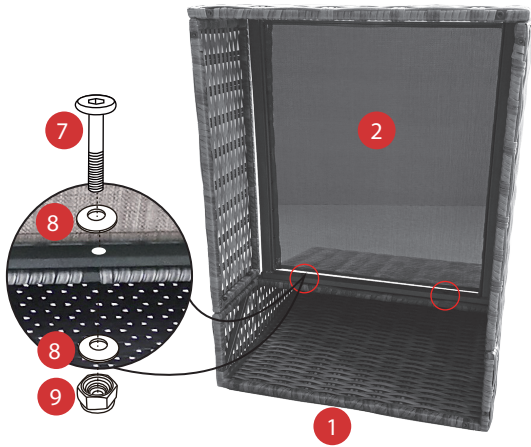

STEP 3

PARTS REQUIRED: 1, 3, 6, 8, & 9
Tighten all bolts by using the supplied Hex key.

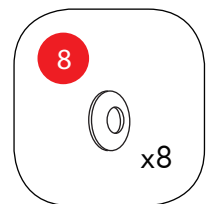
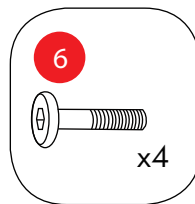
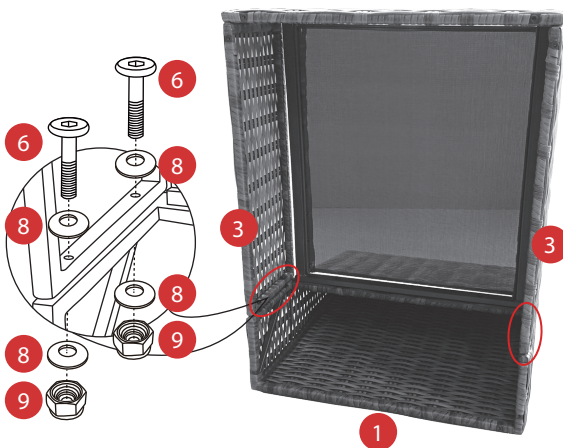

STEP 4

PARTS REQUIRED: 1, 2, 3, 4, 6, & 8
Tighten all bolts by using the supplied Hex key.

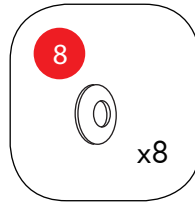
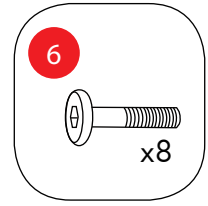
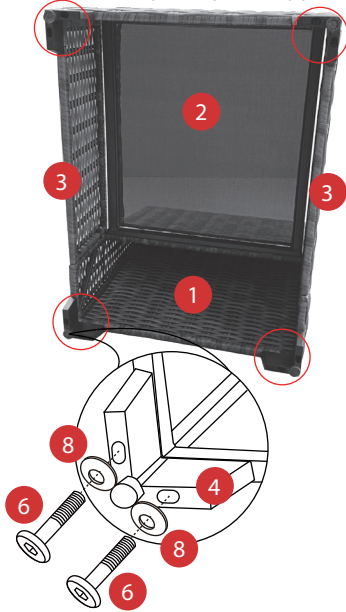

STEP 5

PARTS REQUIRED: 10 & 11



Warranty

- One-year limited warranty.
- Proof of purchase (dated register receipt) is required for warranty claims.
- It remains the customer's responsibility for freight and packing charges to and from the service center.

STOP!

Missing A Part? No Need To Go Back To The Store

The store where you made your purchase does not stock parts for this item.
If you need parts, whether they are missing or damaged,

Call Toll Free:

TEL: 1-877-800-6021

Call us between 9:00 AM and 4:30 PM Eastern Time Monday through Friday
For further assistance, please visit us at service@hcipatio.com