



STEEL SCROLL PARK BENCH WITH CAST IRON BACK

ASSEMBLY INSTRUCTIONS

ITEM# GB-XG-212

SKU# 810588201

DO NOT RETURN THIS PRODUCT TO THE STORE. FOR MISSING PARTS OR QUESTIONS TO THIS PRODUCT PLEASE CALL US AT 1-888-733-8169 OR EMAIL US AT customerservice_01@yeah.net OR customerservice_02@yeah.net OR customerservice_03@yeah.net

IMPORTANT:

Please read all the instructions and warnings before assembling.

Please install all the screws on the product before fully tightened, and note to put the washer to the screw before putting the screw into the screw hole.











WARNING:

- **Use the correct screws as indicated. All screws should be hand tightened until the complete piece is assembled (This will make the assembly process much easier). Once the piece is fully assembled, then go back and tighten all screws with provided tool.**
- Keep all children and pets away from assembly area. Children and pets should be supervised when they are in the area of the product construction.
- Keep assembly area at least 6 feet from any obstruction such as a fence, garage, house, overhanging branches, laundry line or electrical wires.
- Some parts may contain sharp edges. When assembling and using this product, basic safety precautions should always be followed to reduce the risk of personal injury and damage to the product. Please read all instructions before assembly and use.
- The bench is for sitting purpose only. It is not to be used for standing purposes and will not function as a stool or step-ladder. Use on even surfaces only.
- **The bench is not a toy. Bench tested for use at weight of 450 lb (204.5 kg). Improper use of this product or failure to use as directed may result in injury. Not intended for commercial use.**

CARE & MAINTENANCE

- Before using, clean the product completely with a soft dry towel. When not in use, wipe free of any dirt or loose objects, wash with a mild solution of soap and water, rinse thoroughly and dry completely. Do not use strong detergent or abrasive cleaners. Screws can be loosen over a period of usage, please check the screws occasionally and re-tighten if necessary.

PARTS LIST

NO.	Part	Qty	Image	NO.	Part	Qty	Image
A	Bench Arm	2		F	Washer	8	
B	Bench Seat Panel	1		G	Nut	4	
C	Bench Back Panel	1		H	Plastic Cover	4	
D	Short Screw (M6x50mm)	4		I	Allen Wrench	1	
E	Long Screw (M6x55mm)	4		J	Open End Wrench	1	

STEP 1

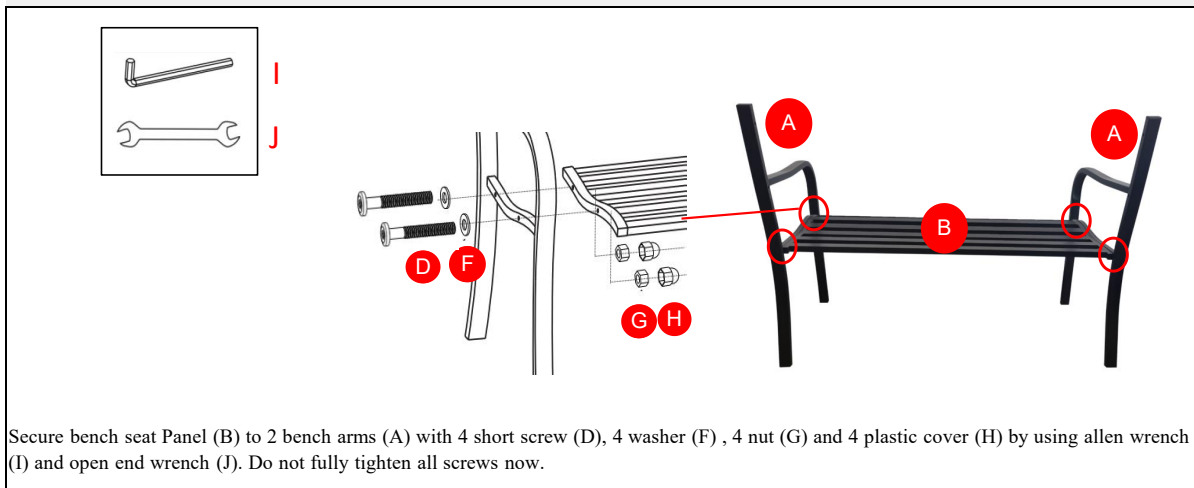

STEP 2

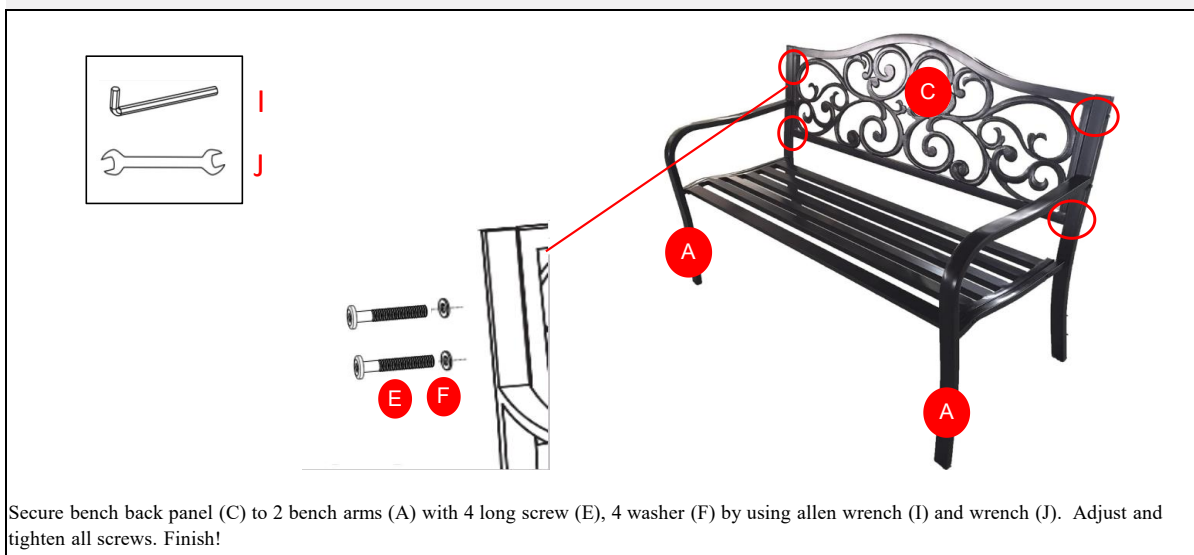

Warranty

One year limited warranty.

Proof of purchase (dated register receipt) is required for warranty claims.

It remains the customer's responsibility for freight and packing charges to and from the service center.