



ASSEMBLY INSTRUCTION

ITEM#: H22SK1227

SKU#: 810580415

PEMBROKE SWIVEL GLIDER

Need help? We are here for you!

1 (877) 800 – 6021

• Toll Free

service@hccipatio.com • Email Address

GENERAL BEST PRACTICES FOR ASSEMBLY:

To Ensure Alignment & Easy Assembly, Secure All Bolts & Washers In Place Before Fully Tightening

Read all instructions before starting

Clear a flat covered space to begin assembly

Always best to do it with a friend

Note that hardware required is provided for every step

Pay attention to orientation

Letter of the part corresponds to a sticker on the product

Number of the hardware corresponds to its letter in the package

Helpful hints provided along the way

Retain these assembly instructions for future reference

WARNINGS:

Regularly check hardware and tighten if necessary

Use the correct bolts as indicated. Do not tighten any of the bolts until the swivel glider is completely assembled.

Do not discard any of the packaging until you have checked that you have all of the parts and fittings required.

Keep children away during assembly. This item contains small parts that can be swallowed by children.

Children should always be under direct adult supervision while using this product.

Chairs are for sitting purposes only. Standing on or misuse of chair may result in damage or injury. Not intended for commercial use. Weight limit is 250 lbs (113 kg).

MAINTENANCE:

Wash frame and fabric parts with mild soap and water, rinse thoroughly, and dry completely. Do not use bleach, acid, or other solvents on the frame or fabric parts.









The cushions may be washed on the surface only by using mild soap and water or a commercial foaming upholstery cleaner if necessary. If washed, rinse well and hang to dry. Do not machine wash or dry.









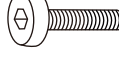

We recommend the use of furniture covers when not in use.

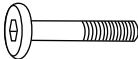
Inspect and tighten all of the bolts and fasteners on a regular basis to ensure the proper performance and safety of your swivel glider.

In order to prolong the life and beauty of your swivel glider, we recommend that it be stored in a dry and protected area during off season periods.

PARTS LIST

PART NO.	MATERIAL CODE	PART	Q'TY
1	HRVS915W-BG	 BACK ASSEMBLY	1
2	HRVS915W-ZG	 SEAT ASSEMBLY	1
3	HRVS915W-SB	 ARM	2
4	HRVS915W-DG	 SUPPORT FRAME	1
5	HRVS915W-ZJ	 SEAT POST	1
6	HRVS915W-ZSG	 DECORATIVE PLASTIC COVER	1
7	HRVS915W-DZ	 BASE ASSEMBLY	1
8	HRVS915W-YG	 SWING BAR	4
9	PTLS-M8-30	 BOLT M8*30	8

10	LS-M6-35	 BOLT M6*35	9
11	LS-M6-15	 BOLT M6*15	4
12	LS-M6-50	 BOLT M6*50	2
13	DP-d6.5-D13	 WASHER d6.5*D13*1.0	16
14	DP-d6.5-D30	 WASHER d6.5*D30*2.0	1
15	DP-d8.5-D17	 WASHER d8.5*D17*1.6	8
16	DP-d8.5-D12.5	 WASHER d8.5*D12.5*1.5	16
17	LM-M6	 JAM NUT M6*1.0	2
18	HRVS915W-BM	 BACK CUSHION	1
19	HRVS915W-ZM	 SEAT CUSHION	1

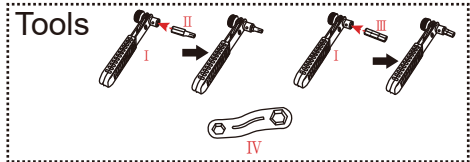

STEP 1

PARTS REQUIRED: 3, 8, 9, 15, & 16
Keep the bolts loose.

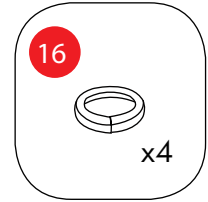
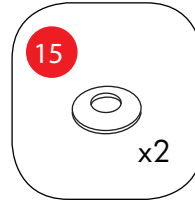
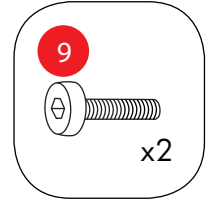
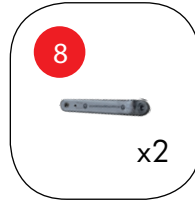
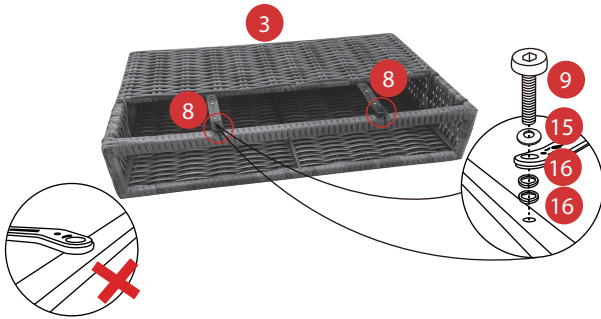

STEP 2

PARTS REQUIRED: 2, 3, 10, & 13
Keep the bolts loose.

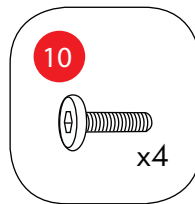
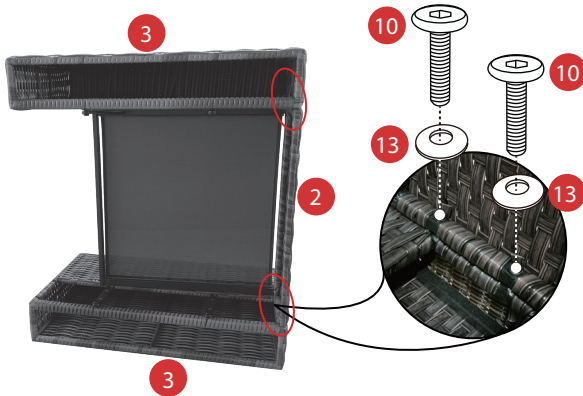

STEP 3

PARTS REQUIRED: 1, 3, 10, & 13
Keep the bolts loose.

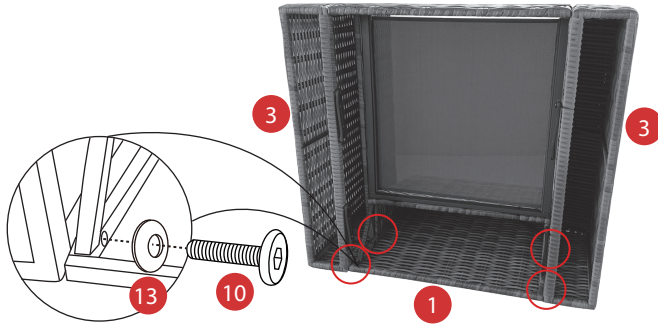
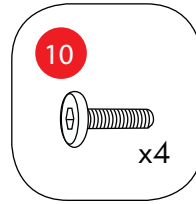

STEP 4

PARTS REQUIRED: 1, 2, 12, 13, & 17
Keep the bolts loose.

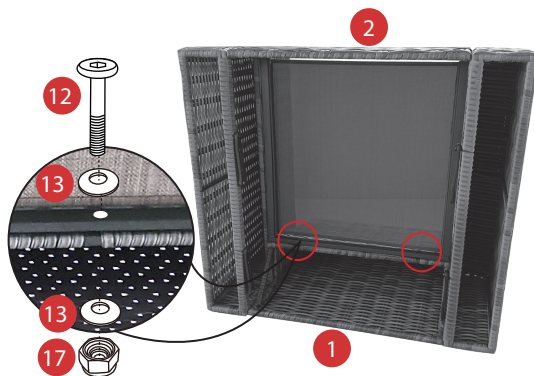
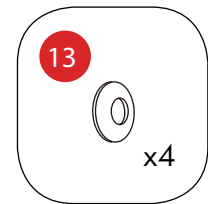
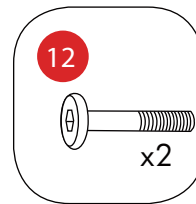

STEP 5

PARTS REQUIRED: 4, 8, 9, 15, & 16
Keep the bolts loose.

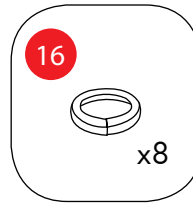
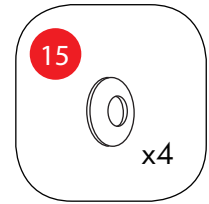
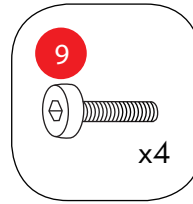
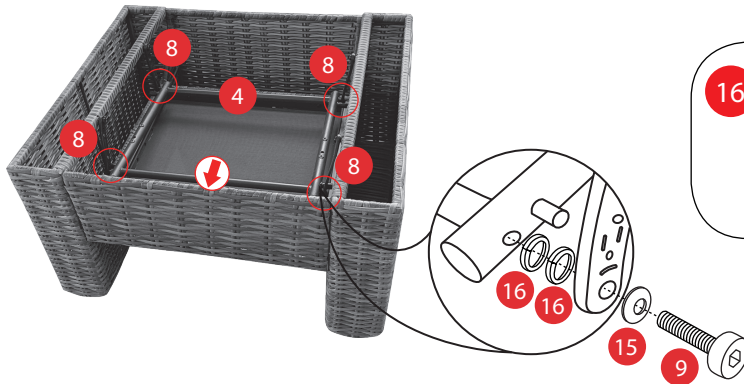

Note:
The labeled arrow marks on the support frame (#4) should coincide with Figure 5 to ensure proper assembly.

STEP 6

PARTS REQUIRED: 4, 5, 11, & 13
Tighten all bolts by using the supplied Hex key.

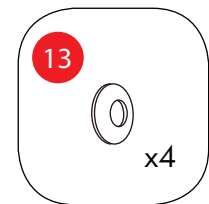
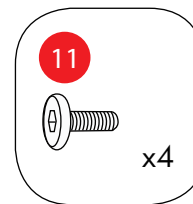
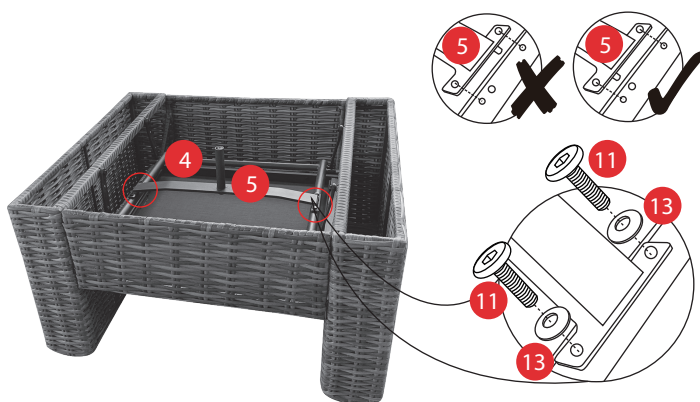

STEP 7

PARTS REQUIRED: 6 & 7

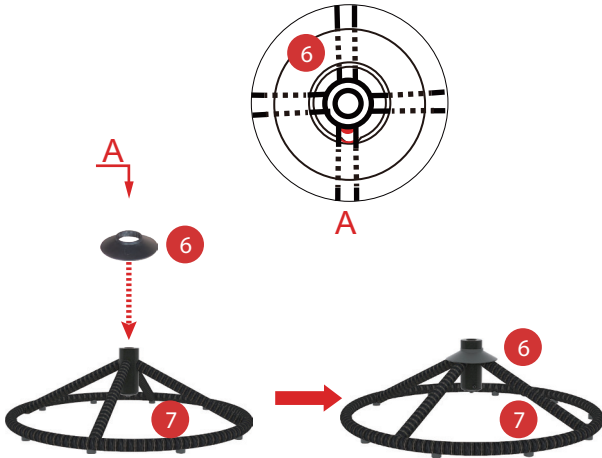
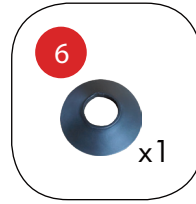

STEP 8

PARTS REQUIRED: 5, 7, 10, & 14

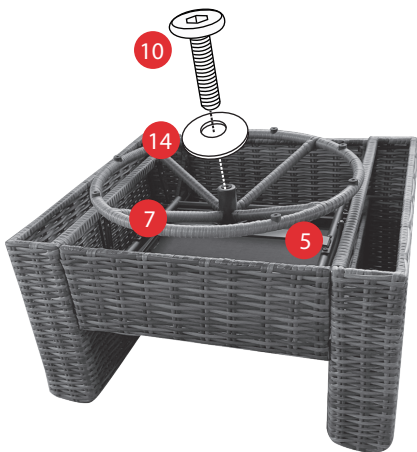
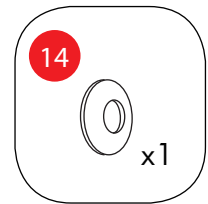
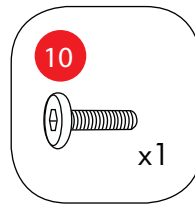

Note:

For ease with installation, we recommend that the seat post (#5) be slightly oiled or waxed before fastening it to the base assembly (#7).

STEP 9

PARTS REQUIRED: 18 & 19



Caution:

To ensure one's safety during use of this swivel glider, make sure that all of the bolts are completely tightened. This chair has the ability to swivel; therefore use by young children should be adult supervised.

Warranty

- One-year limited warranty.
- Proof of purchase (dated register receipt) is required for warranty claims.
- It remains the customer's responsibility for freight and packing charges to and from the service center.

STOP!

Missing A Part? No Need To Go Back To The Store

The store where you made your purchase does not stock parts for this item.
If you need parts, whether they are missing or damaged,

Call Toll Free:

TEL: 1-877-800-6021

Call us between 9:00 AM and 4:30 PM Eastern Time Monday through Friday
For further assistance, please visit us at service@hccipatio.com